

TECHNICAL MANUAL WEIGHT INDICATOR MICROCONTROLLER



E-BATCH: SOFTWARE FOR MULTICOMPONENT DOSAGE SYSTEMS



JIM SMITH COMPANY
17, MAIN STREET
NEW YORK, NY U.S.A

TEST
TARGET 110kg
CYCLE REPORT 01
9/11/09 - 15:22

01 AUTOM. DOSAGE
GRAVEL
SCALE NUMBER 1
DOSE 50kg
DOSED WEIGHT 50kg

02 MANUAL DOSAGE
SAND
SCALE NUMBER 1
DOSE 50kg
DOSED WEIGHT 50kg

CYCLE REPORT
9/11/09 - 15:30
TARGET 110kg
DOSED 110kg
OUT OF TOL. 0kg

3590EXTBATCHBCIO, CPWEBATCH, CPWETF series indicator



INDEX

1. REQUIREMENTS FOR AN EFFECTIVE INSTALLATION	3
1.1 ELECTRICAL PRECAUTIONARY MEASURES	3
1.1.1 CABLE CLASSIFICATION.....	4
1.1.2 RECOMMENDED DISTANCES AMONG CABLES	4
1.1.3 MAXIMUM CABLE LENGTH	5
1.2 EARTHING SYSTEM	5
2. WEIGH MODULE.....	7
3. SETUP ENVIRONMENT	8
3.1 SETUP ENVIRONMENT BLOCK DIAGRAM	10
3.2 DESCRIPTION OF THE STEPS	15
4. CALIBRATION.....	41
4.1 CALIBRATION PROCEDURE.....	41
4.2 LINEARISATION POINTS	43
4.3 ZONE OF USE DIFFERENT FROM THE CALIBRATION ZONE.....	43
4.4 QUICK CALIBRATION OF ZERO	44
4.5 PEAKS FILTER	44
5. DISPLAY OF THE GEOGRAPHICAL UTILISATION AND CORRECTION ZONE OF THE WEIGHING ERROR DUE TO THE DIFFERENT GRAVITATIONAL ATTRACTION BETWEEN THE CALIBRATION AND UTILISATION ZONE.	44
5.1 INDICATION AND/OR DISPLAY OF THE GEOGRAPHICAL UTILISATION ZONE	44
5.2 CORRECTION OF THE WEIGHING ERROR INTRODUCED BY A DIFFERENT GRAVITATIONAL ATTRACTION VALUE BETWEEN THE CALIBRATION AND UTILISATION ZONE.....	45
6. FUNCTION OF THE OPTOISOLATED INPUTS.....	45
7. FUNCTION OF THE OUTPUTS (DEFAULT).....	46
7.1 DIAGRAM FOR DECODING THE OUTPUTS.....	47
7.2 INTERMITTENT ACTIVATION OF THE PRODUCT OUTPUT (JOGGING FUNCTION)	48
8. SERIAL OUTPUTS	48
8.1 RS 485 CONNECTION	49
8.2 PC CONNECTION	50
8.3 PRINTER CONNECTION.....	51
8.4 TRANSMISSION PROTOCOLS.....	51
8.5 TRANSMISSION MODES	54
8.6 SERIAL COMMANDS FORMAT	54
8.7 ADVANCED COMMANDS	57
9. ANALOGUE OUTPUT (OPTIONAL)	64
10. PROGRAMMING THE PRINTOUTS.....	67
10.1 PROGRAMMING EXAMPLE.....	68
10.2 ASCII CODE TABLE	70
10.2.1 Windows 1252 (Latin1)	70
10.2.3 Windows 1253 (Greek).....	72
10.3 LIST OF PRINT BLOCKS.....	73
10.3.1 ORDER BY KIND	73
10.3.2 NUMERICAL ORDER.....	80
10.4 BLOCKS WITH PARAMETERS	87
11. ELECTRICAL CONNECTION SCHEMES	94
11.1 CPWE BACK PANEL	94
11.2 MOTHER BOARD	95
11.3 I/O EXPANSION BOARD (fitted with 3590EXT in IO version or CPWE).....	98
11.4 INTEGRATED CIRCUITS INSTALLATION	99
11.6 LOAD CELL CONNECTOR CIRCUIT DIAGRAM.....	101



1. REQUIREMENTS FOR AN EFFECTIVE INSTALLATION



To obtain the best results it is recommended to install the indicator and the platform (or transducer) in a place with the following conditions:

A flat, level surface on which to rest

Stable and vibration free

No dust or strong vapours

No draughts

Make sure the platform is level or that the loading cells are resting evenly

Moderate temperature and humidity (15-30°C and 40-70%)

Do not install anywhere where there is the risk of explosion

All the indicator connections have to be made respecting the rules applicable in the zone and in the installing environment. Respect the recommended electrical precautionary measures described in section 1.1.

Make sure that the grounding is made correctly, see section 1.2.

Everything not expressly described in this manual has to be considered as improper use of the equipment.

Avoid welding with load cells installed.

Use waterproof sheaths and couplings in order to protect the load cell cables.

Use a waterproof junction box to connect the cells.

1.1 ELECTRICAL PRECAUTIONARY MEASURES

Mains power supply is restricted to within $\pm 10\%$ of the rated voltage

Electric protections (fuses etc.) are provided by the technician installing the instrument.

Respect the recommended minimal distances that are mentioned for the various cable categories, see sections 1.1.1 and 1.1.2.

The extension leads of the load cells or signal amplifiers, used for the connection of the serial ports and analogue output must be within the allowed maximum lengths, see section 1.1.3.

The extension leads of the load cells or signal amplifiers must be screened. In addition they must be laid on their own in a raceway or metal pipe as far away as possible from the power supply cables.

Install "RC" filters on the contactor coils, on the solenoid valves and on all devices producing electric disturbances.

If it is possible that condensation could form inside the weight transmitter it is advisable to leave the instrument powered at all times.

Every shielded cable or not (for instance PC cable, cell cable, power supply cable) connected to the indicator should be as shorter as possible, then you have to come out of the shield the minimum length of cable, then connect to the terminal box;

If the indicator is situated inside an electric panel, the power supply cable should be a shielded cable as shorter as possible, distant from every coil supply cable, inverter, electromotive force, etc. and in addition dedicate an uncoupler transformer in order to feed the indicator only.

1.1.1 CABLE CLASSIFICATION

The various cables are classified depending on the transmitted signals:

Category I

- Field bus, LAN (PROFIBUS, Ethernet, Devicenet...)
- Shielded data cables (RS232 ...)
- Shielded cables for analogue/digital signals < 25V (sensors, load cells...)
- Low tension power supply cables (< 60V)
- Coaxial cables

Category II

- DC supply cables with tension > 60V and < 400V
- AC supply cables with tension > 25V and < 400V

Category III

- Power supply cables with tension > 400V
- Telephone cables

Category IV

- Any cable subject to lightning

1.1.2 RECOMMENDED DISTANCES AMONG CABLES

- When the cables are laid next to each other, these must be at the distances in the table below
- These distances are valid if in the air; these are reduced if the raceways are separated by grounded metallic shields.
- Different category cables can cross each other (90°)

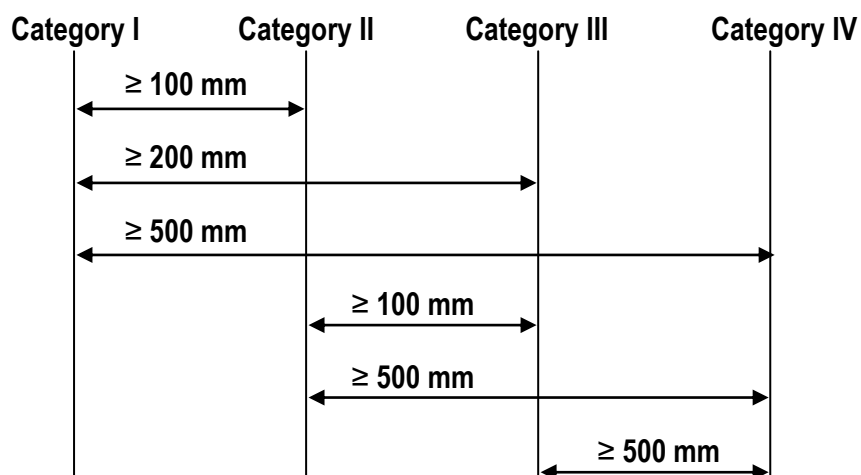

1.1.3 MAXIMUM CABLE LENGTH

LOAD CELL CABLE

The maximum reachable length from the line using the appropriate load cell cable is:

- 50 m with cable 6 x 0,25 mm²
- 100 m with cable 6 x 0,5 mm²

RS232 CABLE

The maximum reachable length from the line using the RS232 cable with a maximum baud rate of 19200, is about 15 m.

RS485 CABLE

The maximum reachable length from the line with the use of the appropriate cable for RS 485 connections (see section 8.1), and with baud rate up to 9600, is about 1200 meters.

ANALOG OUTPUT CABLE

The maximum length of the analogue output cable in current is:

- 100 m with cable 2 x 0,25 mm²
- 150 m with cable 2 x 0,5 mm²
- 300 m with cable 2 x 1 mm²

The maximum length of the analogue output cable in voltage is:

- 50 m with cable 2 x 0,25 mm²
- 75 m with cable 2 x 0,5 mm²
- 150 m with cable 2 x 1 mm²

1.2 EARTHING SYSTEM

For the right earthing and the optimal functioning of the system, it is necessary to connect the indicator, the load cells, the possible junction box and the weighing structure to the earth.

All earthing cables must have the shortest possible length in order to minimize their resistance.

INDICATOR

Connect the external earthing of the indicator to the earth through copper cables having at least a 16 mm² cross-section.

LOAD CELLS AND JUNCTION BOX

The earthing must be done by connecting the earthing cables to a ground bar with cables having a cross-section of at least 16 mm² and by connecting the ground bar to a ground pole with a cable having a cross-section of at least 50 mm².

- In the case the load cells are connected to the indicator through a junction box, it is necessary to connect the sheathing both of cells cables and of indicator cable to the earthing of the junction box (refer to the junction box manual) and connect this to the earth through copper cables having at least a 16 mm² cross-section.
- If the load cells are connected directly to the indicator (without the use of the junction box), one should connect the shieldings of the load cell cables to the grounding point (or earthing bar) inside the container.
- If the weighing system concerns large and/or outdoor structures, like weighbridges, and the junction box is connected to the indicator in a distance that is greater than 10 m, or in the presence of noise, the cable shield must be earthed both in the junction box and in the indicator, and the two ground leads must be connected with an earth cable having a cross-section of at least 16 mm².

WEIGHING STRUCTURE

Connect the weighing structure and the possible connected structures (for example silos that release material on the weighing structure) to the earth through copper cables having at least a 16 mm² cross-section.

Furthermore it is necessary that for each cell, one connects the upper part with the lower part of the load cell through a copper braid section not less than 16 mm²; the upper part must be short-circuited with the surface of the weighing structure and the lower part must be grounded through a copper braid section not less than 16 mm².

CONNECTED SERIAL CABLES AND INSTRUMENTS

Connect the shield of the serial cable at the grounding point (or grounding bar) inside the container (on the end of the cable toward the indicator) and at the earth connection of the connected instrument (on the end of the cable toward the indicator), and ground the earth connection of the connected instrument, through a copper cable section not less than 16 mm².

To avoid possible side effects, the earth references of the connection and power supply cable of the indicator and of the connected instrument **must be at the same potential**.

GENERAL NOTES:

- All the grounding cables must have an adequate length, in order to obtain an overall resistance of grounding system less than 1 Ω.
- In the case the weighing system regards great and/or outdoor structures, like weighbridges:
 - The grounding connection is to be made by connecting the grounding cables to a grounding bar and the grounding bar to the grounding pole with a cable section not less than 50 mm².
 - the cable cross-section must be greater (for example 50 mm² instead of 16 mm² and 100 mm² instead of 50 mm²), because the voltage into play is greater (for example thunderbolts);
 - the ground pole must be positioned at a distance of at least 10 metres from the weighbridge structure;
 - one needs to open the SENSE inside the indicator in order to offset the drifts due to the increase in temperature.
- One should check and remove, if necessary, the connection between the earth and the neutral wire of the electrical installation.

2. WEIGH MODULE

After having followed the instructions regarding the platform or weigh module, the screened cable leading from the load cell(s) must be connected to the instrument through the terminal board, see section 11.1

The terminal board of the indicator may be connected to the 6-wire weigh module (with use of SENSE), or simply 4-wire; for this, through jumper J7 and J8 it is possible to choose whether to short-circuit the SENSE with the POWER SUPPLY (jumpers closed) or not (jumpers open).

The sense allows compensating for any drops in voltage in the part of the cable that connects the instrument to the transducer. It is useful when the distance between the indicator and the transducer is greater than 10 m.

The 4-pin connectors instead allow just the 4-wire connection.

To make the connection, qualified personnel must open the instrument (see terminal board connections section 11.1).

TAKE NOTE: if there is A SINGLE LOAD WEIGH MODULE, it is possible to make a 6-wire connection (use of the sense) directly to the terminal board, removing the J7 and J8 jumpers.

If there are two or MORE WEIGH MODULES, one should close the J7 and J8 jumpers (sense and power supply short-circuited) and make the 4-wire connection.

Normally the indicator comes already connected to the platform and is ready to use. If this is a LEGAL version instrument, access to the connection will be subject to a legal SEAL.

Follow the instructions for preparing the platform for use.

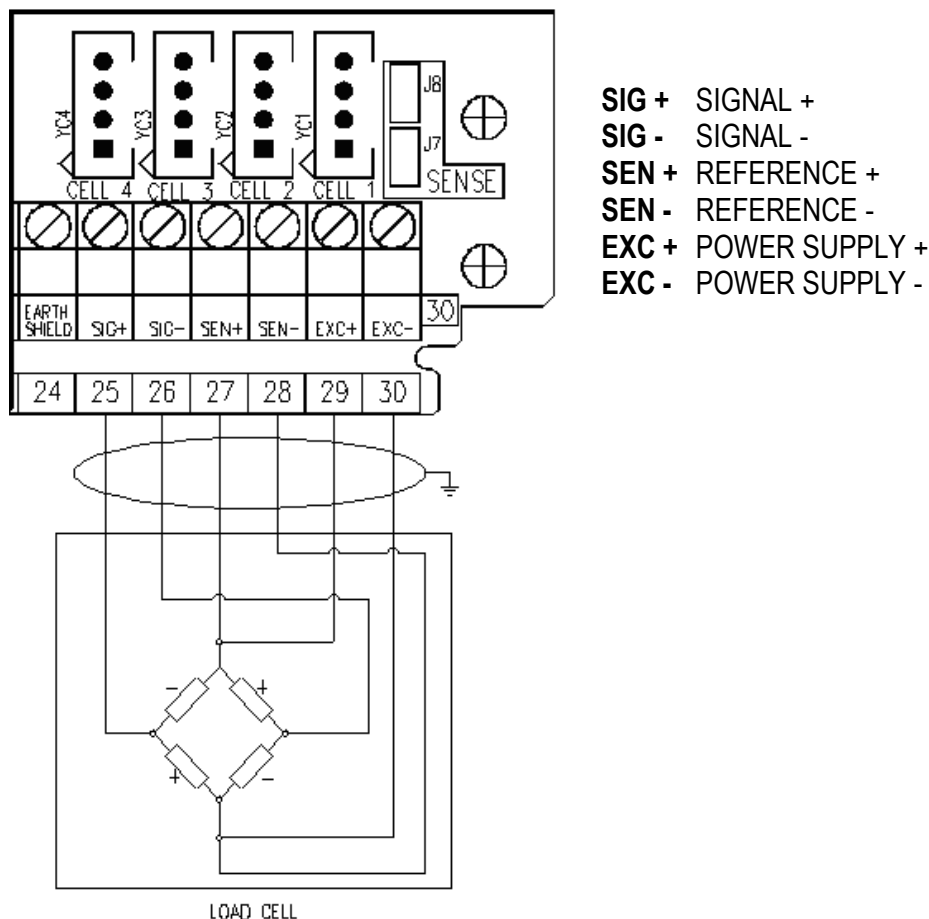

See section 11.1 for further information.

3. SETUP ENVIRONMENT

By "SETUP environment" we mean a certain menu inside which all the indicator operating parameters can be set. To enter it, turn on the instrument and, during the countdown, press the TARE key for an instant.

Once in the set-up environment, the instrument displays the first step.

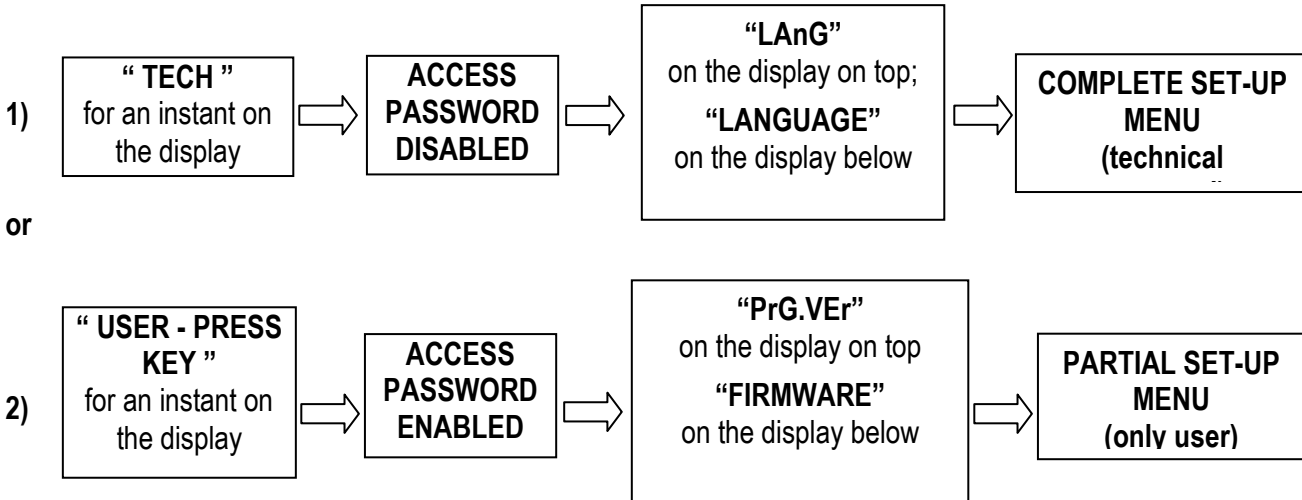

If you are in choice 2) and you want to access the complete set-up menu one should:

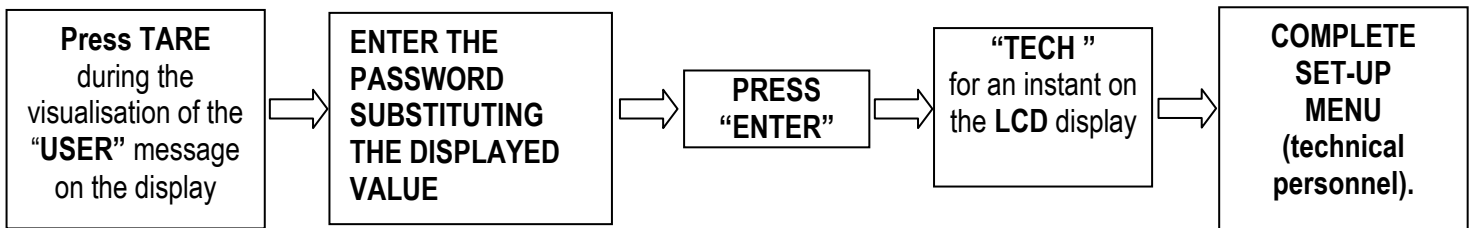

In the parameter description and in the block diagram

- The **METRIC** parameters are shown with the (*) symbol, and, with approved instrument, these may not be visible or read only. See the explanation of the parameter for the details.
NOTE: The indicator is approved when the J1 jumper of the motherboard is closed(see the electrical scheme in the final chapter).
- The **CONDITIONAL STEPS** are shown with the (§) symbol, and are not displayed in specific conditions, shown in the step description.
- The **DEFAULT VALUES** are shown with the (!) symbol placed next to the step and at the end of it.

FUNCTION OF THE KEYS IN THE SET-UP ENVIRONMENT

KEY	FUNCTION
F6, F7	Allow to scroll forwards and backwards in the menu steps or in the parameters inside a step
Fn / ENTER	Allows to enter a step or to confirm a parameter inside a step.
C / DEL	Allows to exit a step without confirming any changes made and to go to the previous level
NUMERIC KEYBOARD	Allows entering an alphanumeric input.

The display show the current parameter and its description; generally, when one exits a step the instrument places itself on the following step.

TO EXIT THE SET-UP ENVIRONMENT, PRESS THE C KEY MANY TIMES UNTIL THE INDICATOR SHOWS:



**EXITING SETUP:
SAVE ?**

CONFIRM WITH ENTER TO SAVE CHANGES MADE OR PRESS ANOTHER KEY TO NOT SAVE.

3.1 SETUP ENVIRONMENT BLOCK DIAGRAM

The following diagram represents the structure of the indicator's set-up environment; each step has been described in detail in the following paragraph 3.2.

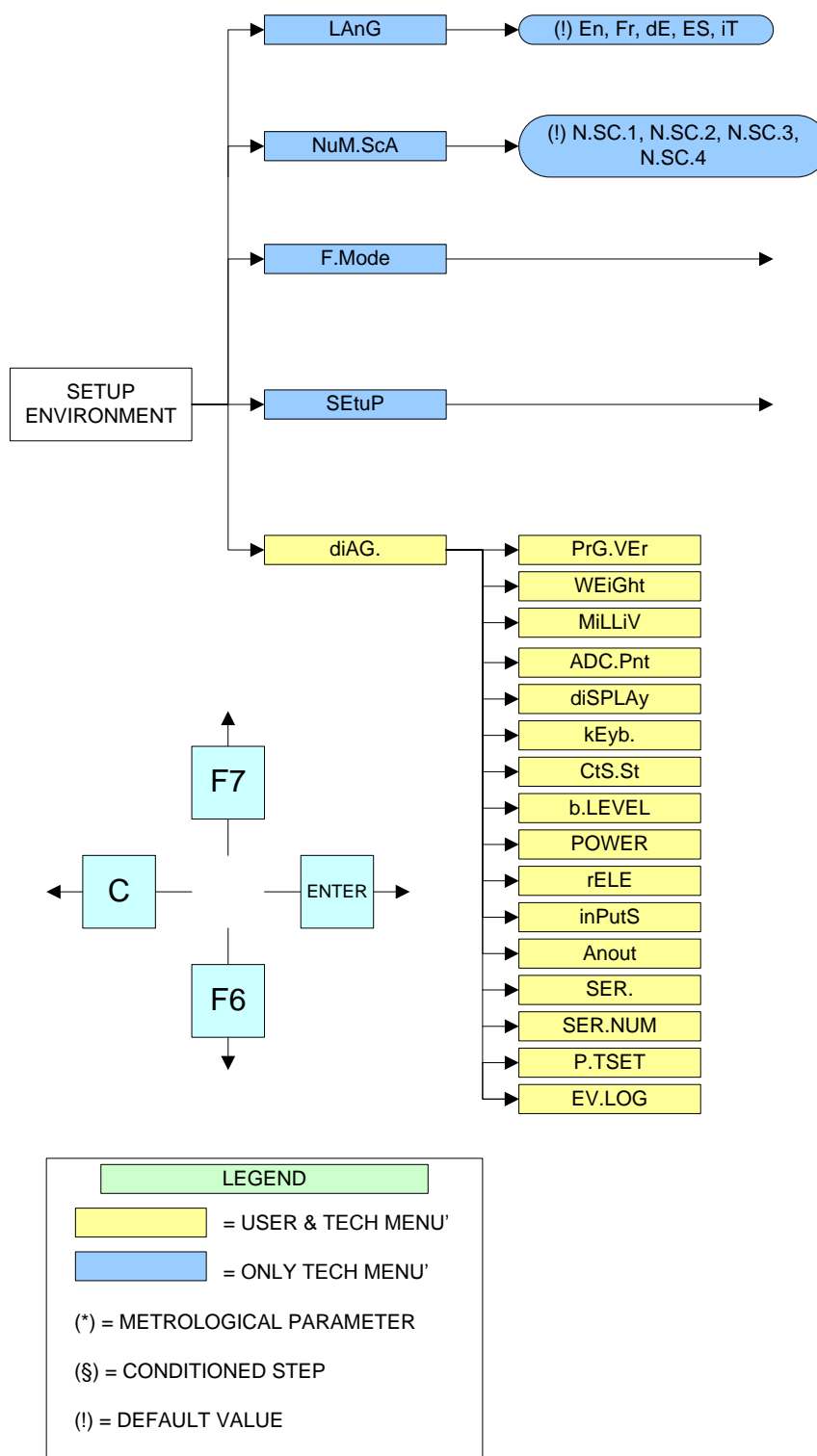

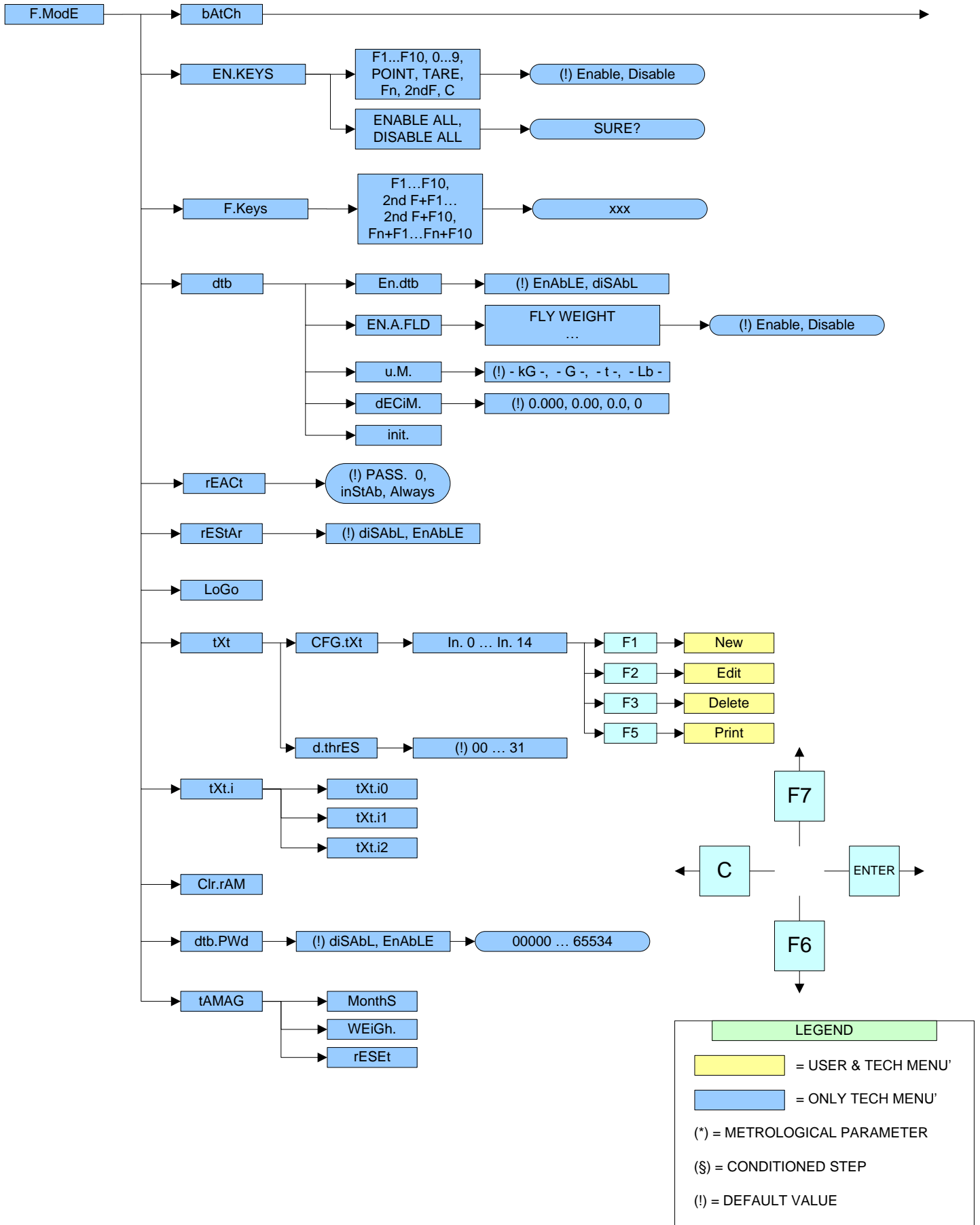

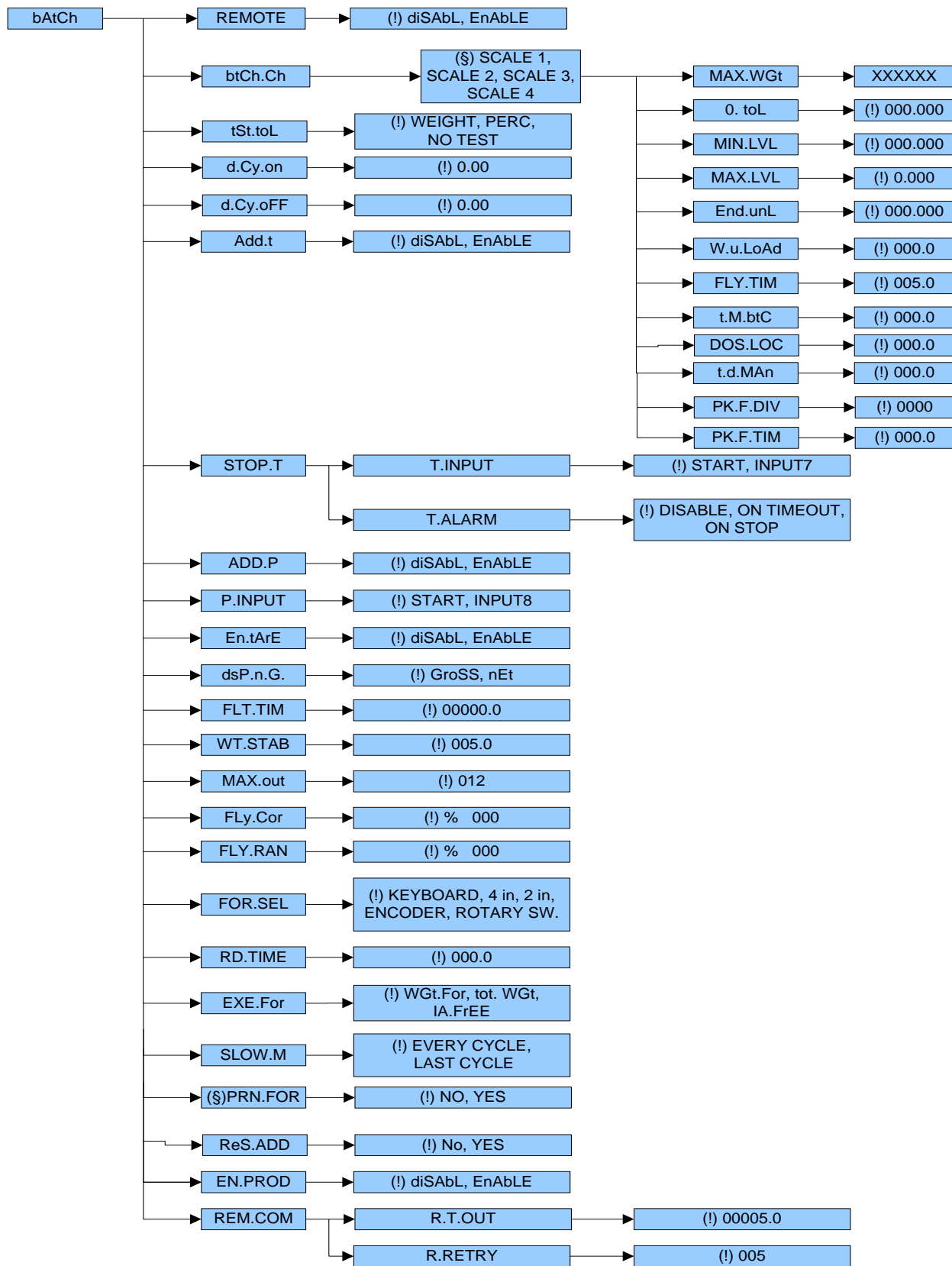

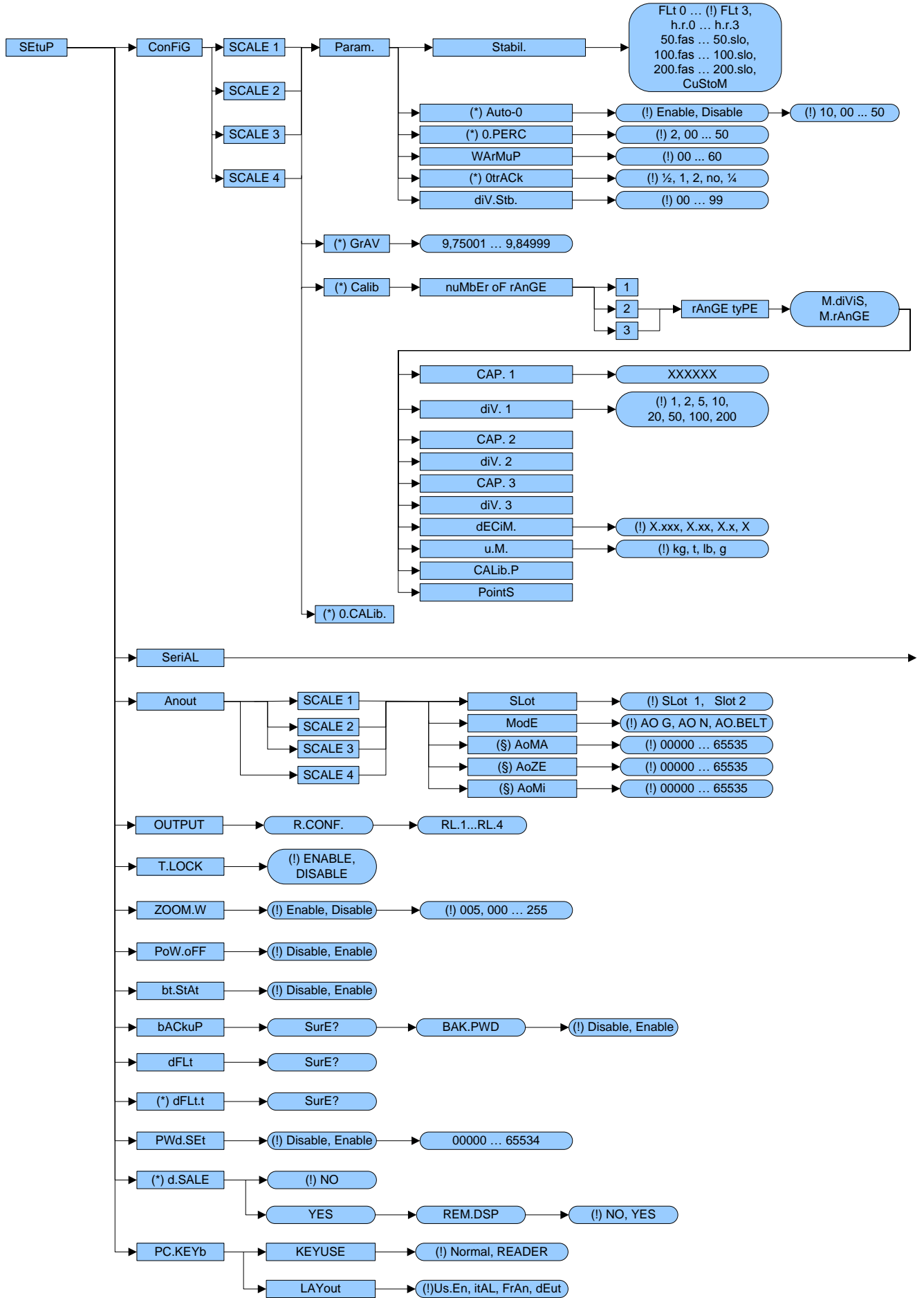

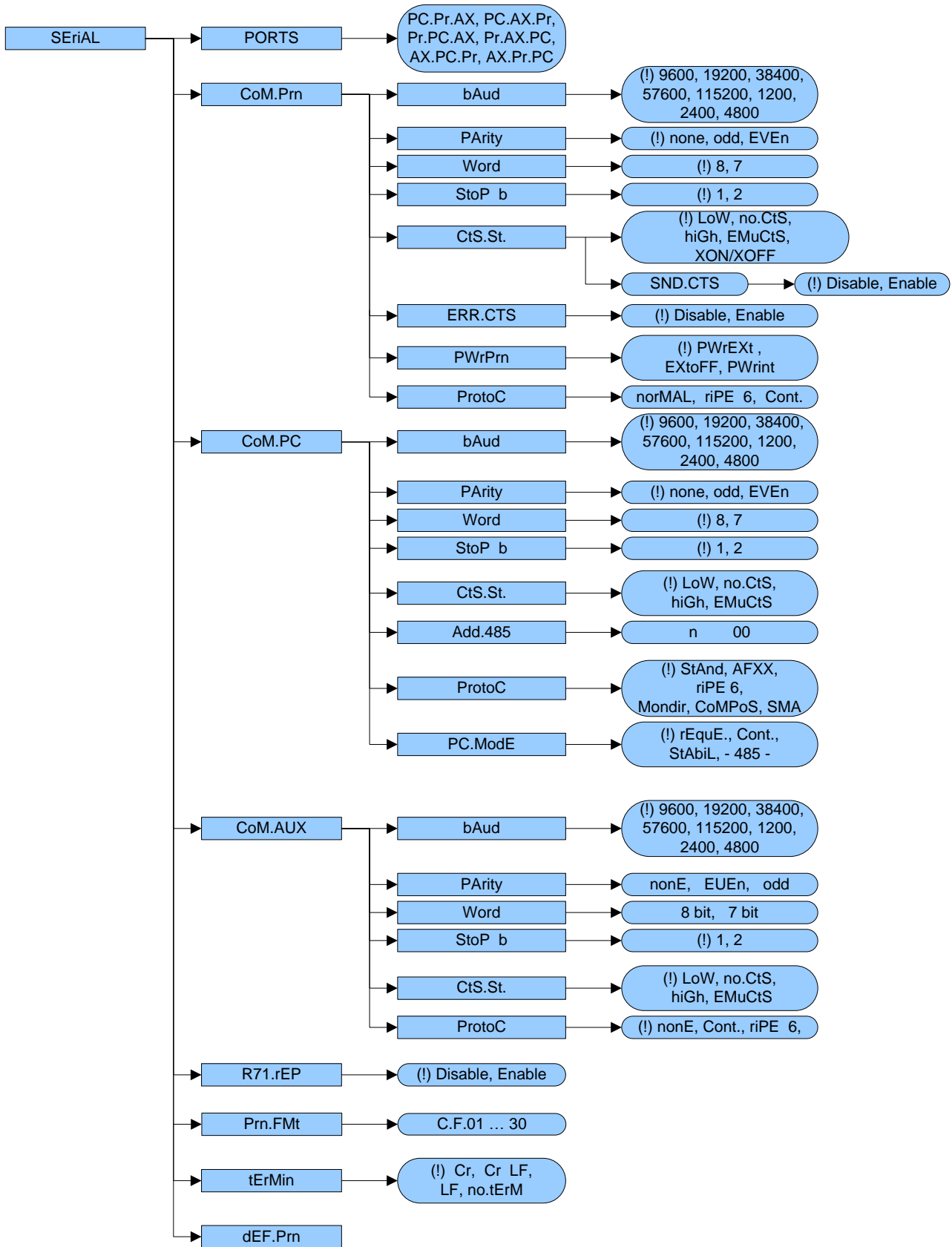

3.2 DESCRIPTION OF THE STEPS

<< LAnG >> FIRMWARE LANGUAGE

Parameter	Language	Used Codepage (see section 10.2)
- En	English	1252 Windows Latin 1
- Fr	Français	1252 Windows Latin 1
- dE	Deutsch	1252 Windows Latin 1
- ES	Español	1252 Windows Latin 1
- It	Italiano	1252 Windows Latin 1

(!) En

<< nuM.SCA >> NUMBER OF CONNECTED SCALES (*)

- n.SC. 1: (1 scale)
- n.SC. 2: (2 scales)
- n.SC. 3: (3 scales)
- n.SC. 4: (4 scales)

(!) n.SC. 1

(*) In case of approved instrument the parameter is read only.

<<F.ModE>> FUNCTIONING MODE

In this step one sets the scale functioning mode:

<<bAtCh>> DOSAGE PARAMETERS

<<REMOTE>>REMOTE COMPONENT ONLY

In this step you enable remote components excluding the other scales that are connected to the indicator, then the indicator can be used simply as a central control unit.

<< btCh.Ch >> SCALE CONFIGURATION

NOTE: If various scales are connected, once entered in the step, one should select the scale to be configured.

<<MAX.WGT>>: MAXIMUM WEIGHT

This is the maximum weight value which can be loaded onto the scale when executing a formula, which is normally programmed as the full scale value. The indicator, when checking whether the weight on the scale is greater than the maximum weight, it takes into consideration also the weight zeroed when the dosage is started.

NOTE:

- Pmin= 000.000Kg; Pmax= value set in the capacity, in **Cap. 1** parameter, if just one range is used, **Cap. 2** if a double range is used or **Cap. 3** if the triple range is used.
- The **Cap. 3** capacity must always be **greater than Cap. 2**, and **Cap. 2** must always be **greater than Cap. 1**.

The entered value is expressed in the unif of measure of the selected scale.

We advise to enter a maximum value less than the silo capacity.

(!) 000.000

<<0.TOL>> ZERO TOLERANCE WEIGHT (Kg)

If the minimum and maximum tare weights have not been entered for the selected formula (**USER MAN. REF.**) the zero tolerance weight is the maximum weight which can be on the scale when the dosage is begun: if the weight of the material is less than the value set in this parameter; upon the dosage START this material is automatically zeroed and the operations can start; otherwise an OUT OF ZERO error is signalled.

NOTE: Pmin= 000.000Kg; Pmax= value set in <<MAX.WGT>> parameter.

(!) 000.000

<<MIN.LVL>> MINIMUM LEVEL THRESHOLD

Set the weight threshold below which the linked output of minimum level exceeded is enabled.

The entered value is expressed in the unit of measure of the selected scale.

(!) 000.000

<<MAX.LVL>> MAXIMUM LEVEL THRESHOLD

Set the weight threshold beyond which the linked output of maximum level exceeded is enabled.

The entered value is expressed in the unit of measure of the selected scale.

(!) 000.000

<<END.UNL>> UNLOADING END THRESHOLD

Set the threshold which defines the end of the total unloading.

This threshold, added to the target of the split unloading activity defines also the partial unloading end threshold.

For the functioning specifics see section 13.1.3, **USER MAN.REF.**

The entered value is expressed in the unit of measure of the selected scale.

(!) 000.000

<<W.U.LOAD>> WAIT TIME FOR DISCHARGE END (sec)**For unloading dosages**

Wait time for terminating a discharge activity from when the weight value on the scale goes below the TOTAL UNLOADING END THRESHOLD value (see the description of the dosage cycle, **USER MAN.REF.**). The discharge relay, during this time, remains active.

NOTE: t min= 00000.0 sec ; t max= 99999.9 sec

(!) 00000.0 sec

<<FLY.TIM>> FLIGHT WAITING TIME (sec.)

The dosage is interrupted (and relay 1 is also disabled) in the moment in which the TARGET minus the MATERIAL WEIGHT IN FLIGHT is reached; after this a wait time starts equal to the FLIGHT WAIT TIME in which one presumes that there is still material on the scale and the FINAL WEIGHT is reached.

NOTE: t min= 00000.0 sec ; t max= 99999.9 sec

(!) 00000.0 sec

<<T.M.BTC>> MAXIMUM TIME FOR THE DOSAGE (sec.)

Maximum time for executing of the formula. Once this time has passed from the beginning of the dosage, if the formula is not ended, the system has a dosage out of time error.

Programmed at 0, it has no effect.

NOTE: t min= 00000.0 sec ; t max= 99999.9 sec

(!) 00000.0 sec

<<DOS.LOC>> DOSAGE LOCK TRIGGERING TIME (sec.)

It is a timer which is similar with maximum dosage time (see the previous option), but the timer resets when the weight decreases (in unload activities) or increases (in load activities: auto, manual dosage and manual weight) during the dosage.

If the set time has passed and the weight isn't increased or decreased, the instrument goes into error status, while the ERROR relay (OUT3) is activated and the message "DOSAGE LOCKED" is displayed.

Programmed at 0, it has no effect.

NOTE: t min= 00000.0 sec ; t max= 99999.9 sec

(!) 00000.0 sec

<<T.D.MAN>> WAIT TIME FOR AUTOMATIC END OF MANUAL DOSAGE (sec.)**For manual loading dosages**

Maximum waiting time during the loading phase which can elapse from the reaching of the target and the manual ending of the activity, which reached the instrument ends automatically the activity: if in the loading phase, once the set target is reached, a START IMPULSE is not given within this time period (to pass to the following activity), the indicator automatically passes to the tolerance check.

For the functioning specifics see section **13.1.2, USER MAN.REF.**

NOTE: t min= 00000.0 sec ; t max= 99999.9 sec

(!) **00000.0 sec**

<<PK.F.DIV >> MAXIMUM WEIGHT VARIATION IN TIME <<PK.F.TIM >>

This step allows to configure the number of divisions corresponding to the maximum weight variation allowed in the time window <<PK.F.TIM >> during the dosages in loading, which once exceeded enables the peak filter function (see section 4.5 for further details).

By setting the value 0, the control will be disabled.

NOTE: Min = 0000; MAX = 9999.

(!) **0000**

<<PK.F.TIM >> BATCHING-PEAK ELIMINATION TIME (BATCH RIPPLING SMOOTHER FILTER)

This step allow to configure the time that the instrument takes into consideration to check if the weight variation is greater than the value set in the previous step, and to enable the peak filter function (See section 4.5 for further details).

The 0 value disables the checking.

NOTE: t min= 00.0 sec ; t max= 25.5 sec

(!) **00.0**

<<TST.TOL>> ENABLES TOLERANCE TEST

The step allows to choose different type of check on the dosage accuracy (see section 13.4 in the user manual (**USER MAN.REF.**))

- **NO TEST** tolerance checking disabled

- **WEIGHT** tolerance enabled in weight mode

- **PERC** tolerance enabled in percentage mode, in other words tolerance is expressed in percentage of the target and not in weight when you insert tolerance value in the ACTIVITY archive.

(!) **WEIGHT**

<<D.CY.ON>> TIME OF AN "ON" PHASE OF THE PRODUCT OUTPUT DURING THE FINE DOSAGE (sec.)

For automatic dosage activity and for the partial or splitted unloading activity, with <<MAX.out>> equal or less than 8.

When the target weight minus the slow weight and the flight weight is reached, the linked fine dosage output can be opened and closed according to the "on" phase set in this step (TAPPING) and "off" phase set in the following step, until the flight weight is reached.

By setting a value equal to 0 the tapping function is disabled.

NOTE: d.CY.on min= 0.00 sec ; d.CY.on max= 2.50 sec

(!) **0.00 sec**

<<D.CY.OFF>> TIME OF AN "OFF" PHASE OF THE PRODUCT OUTPUT DURING THE FINE DOSAGE (sec.)

For automatic dosage activity and for the partial or splitted unloading activity, with <<MAX.out>> equal or less than 8.

When the target weight minus the slow weight and the flight weight is reached, the linked fine dosage output can be opened and closed according to the "off" phase set in this step (TAPPING) and "on" phase set in the previous step, until the flight weight is reached.

By setting a value equal to 0 the tapping function is disabled.

NOTE: d.CY.off min= 0.00 sec ; d.CY.off max= 2.50 sec

(!) **0.00 sec**

<<ADD.T>> ENABLING DOSED WEIGHT SUM DURING THE TIMER ACTIVITY

It's possible to select whether the eventually added weight which detected at the end of a timer activity, is summed to the dosed total weight.

EnAbLE: enabled function

diSAbl: disabled function

(!) **diSAbl**

<<STOP.T>> PARAMETERS CONFIGURATION TIMER**<<T.INPUT>> STOP MODE**

NOTE: The function has no effect if one set "**NOT STOPPABLE**" in the programming of timer activity.

START Timer stoppable through start command (INPUT 1 or F6 key)

INPUT7 Timer stoppable through INPUT7

(!) **START**

<<T.ALARM>> ALARM MODE

This step allows to enable one alarm function during the timer activity

DISABLE alarm disabled

ON TIMEOUT the relay error is enabled at the end of the timer (if the timer activity isn't stopped before the end).

ON STOP the relay error is enabled when the timer activity is stopped before the end.

For the functioning specifics see section 13.1.5.1, **USER MAN.REF.**

(!) **DISABLE**

<<ADD.P>> ENABLING DOSED WEIGHT SUM DURING THE PAUSE ACTIVITY

It's possible to select whether the eventually added weight which detected at the end of a pause activity, is summed to the dosed total weight.

EnAbLE enabled function

disable disabled function

(!) **diSAbl**

<<P.INPUT>> PAUSE ACTIVITY ADVANCEMENT MODE

In this parameter it is possible to set the advancement mode of a pause activity:

START Advancement through the START command (INPUT 1 or F6 key)

INPUT8 Advancement through the INPUT8

(!) **START**

<<EN.TARE>> ENABLING OF AUTOMATIC TARE

For loading dosages

It is possible to select whether the gross weight on the scale is tared or not at the dosage start.

diSAbl:

- if no tare value has been entered, the entire weight on the scale is zeroed;
- while if a semiautomatic or manual tare is entered, the net weight is considered to be the dosage weight start.

EnAbLE: the gross weight on the scale is entirely tared; therefore the dosage always starts with the net weight at zero.

(!) **diSAbl**

<<DISP.N.G>> NET/GROSS WEIGHT DISPLAY DURING THE UNLOADING ACTIVITY

It's possible to select whether to view the gross weight (GroSS) or the net weight (nEt) on the scale during the unloading activity.

(!) **GroSS**

<<FLT.TIM >> FILTERING TIME (sec)

Wait time which elapses:

- In the automatic dosages and in the partial/fraction unloads, from the reaching of the TARGET – FLIGHT WEIGHT threshold (end of the fine dosage) and the beginning of the FLIGHT WAIT TIME;
- In the total unloads, between the reaching of the TOTAL UNLOADING END THRESHOLD and the beginning of the WAIT TIME FOR THE THRESHOLD END.

For the functioning specifics see section 13.1.7, **USER MAN.REF.**

(!) **00000.0 sec**

<<WT.STAB>> WAIT STABILITY TIME (sec.)

This function allows to check whether the weight on the scale is stable when the START command is given.

The signal coming from the scale's load cell must be stable when the START command is given (or in the moment in which a dosage must start in a repetition of cycles), or in any case it must become stable within the time set here; if the weight is unstable after passing the wait time, the "INSTABILITY ERR" error message is displayed, and the dosage does not begin. If one sets a time value equal to zero, the check becomes instantaneous in the moment in which a start impulse is given.

NOTE: t min= 00000.0 sec; t max= 99999.9 sec

(!) **00005.0**

<<MAX.OUT>> MAXIMUM NUMBER OF OUTPUTS

In this step one sets the maximum number of programmable outputs when entering a formula. See section 7 for further details.

(!) **012**

<<FLY.COR>> FLIGHT CORRECTION PERCENTAGE**For automatic dosages**

In this parameter it can be decided (and in which percentage) to carry out an automatic correction of the flight weight depending on the one performed in the previously dosage.

The 0 value disables the automatic flight correction.

By setting a number between 1 and 100 it will be executed the automatic correction of the flight weight, based on the one obtained in the previous dosage, in the percentage set, only if the dosed flight weight is within the tolerance range set in the << FLY.RAN >> step.

This parameter is valid for all the automatic programmed dosage activities.

For the functioning specifics see section 13.5, **USER MAN.REF.**

NOTE: min= 0%; max= 100%

(!) **000**

<<FLY.RAN>>DOSED WEIGHT RANGE FOR THE FLIGHT CORRECTION FUNCTION**For automatic dosages**

In this step a tolerance range of dosage weight can be set, as a percentage of the target activity, for the correction of flight weight, enabled in step << FLY.COR >>.

By setting a number between 1 and 100, the weight correction enabled in step << FLY.COR >> will be applied within this range (even if it is out of tolerance). Outside of this range, it will not be applied any correction of the flight weight.

If set to 0 the FLY.RAN, the tolerance applied is the one in <<tSt.toL>> step.

(!) **000**

<<FOR.SEL>> FORMULA SELECTION MODE

The selection of the formula to be carried out takes place in one of the modes shown below:

- **KEYBOARD:** selection from keyboard.
- **4 IN:** selection through the binary combination of 4 external inputs.
- **2 IN:** selection of previous/following formula through 2 external inputs.
- **ENCODER:** selection of previous/following formula through 2 external inputs.
- **ROTARY SW.:** not used in this application.

For the functioning specifics see section 11.2.2, **USER MAN.REF.**

(!) **KEYBOARD**

<<RD.TIME>> MAXIMUM DATA READING WAIT TIME (sec.)

The instrument waits for this time before passing to the following phase in order to allow the reading of the data relative to the phase made.

The function is enabled after the possible tolerance test at the end of the activity (both load and unload)

Programmed at 0, it has no effect.

NOTE: t min= 00000.0 sec ; t max= 99999.9 sec

(!) **00000.0**

<<EXE.FOR>> FORMULA WEIGHT SETTING MODE

This function allows to decide the execution mode of the stored activity:

- **FORMULA WEIGHS (WGt.For):**
The dosage is carried out following the targets set in the formula.
- **SETTING OF THE TOTAL WEIGHT (tot.WGt):**
Here one sets the total weight which one wants to dose with the selected formula; the instrument automatically recalculates the weight to be dosed for each single activity of the formula on the basis of the percentage which each activity occupies in respect to the formula total (see section 13.2.3 **USER.MAN.REF.** for further details).
- **FIRST FREE COMPONENT (1A.FrEE):**
The first component is manually dosed; the instrument, on the basis of the dosed weight, recalculates the weight to be dosed for each following activity proportionally in respect to the total; therefore in this functioning mode the first activity of the formula has to be a manual dosage or manual weight.
By selecting this functioning mode, it will be possible to select only the formulas in which the first activity is a manual dosage or manual weight. For further details, see section 13.2.2 of the user manual (**USER.MAN.REF.**).

For the functioning specifics see section 13.2, **USER MAN.REF.**

(!) **WGt.For**

<<SLOW.M>> SLOW EXECUTION MODE

For "TOT.WGT" formula executing mode

In this parameter one decides when the slow dosage will be performed:

EVERY CYCLE every cycle

END CYCLE only at the last cycle (if the cycles are plus one)

For the functioning specifics see section 13.2.3.1, **USER MAN.REF.**

(!) **EVERY CYCLE**

<<PRN.FOR>> PRINT FORMULA UPON SET TOTAL WEIGHT CHANGE (§)

For "TOT.WGT" formula executing mode

This step decides whether the formula is printed or not, when set total weight is changed.

NO when the set total weight is changed, it is not asked to print the formula.

YES when the set total weight is changed, it is asked to print the formula, while the display shows "PRINT FORMULA?" message, one is asked to confirm with **ENTER** key, or press **C** key to exit it.

(§) this parameter is visible only if "TOT WGT" mode has been enabled.

(!) **NO**

<<RES.ADD>> ADD WEIGHT WHEN CYCLE IS RESET

This step allows to add the dosed weight to formula, activity, totals when the cycle is reset.

No not allow to add weight.

YES allow to add weight.

(!)No

<<EN.PROD>> ENABLING PRODUCTION PROGRAM FUNCTION

This step allows to enable the production program function.

Disable disabling production program

Enable enabling production program

For the functioning specifics see section 13.7, **USER MAN.REF.**

(!) Disable

<<REM.COM>> COMMUNICATION CONFIGURATION FOR REMOTE COMPONENTS

NOTE: For the functioning specifics see section , **USER MAN.REF.**

<<R.T.OUT>> REMOTE COMMUNICATION TIMEOUT (sec.)

The step allows to set maximum communication timeout for the remote components, if the set time elapsed, the communication still fails, the indicator will continually send the same commands to the remote instrument until the number of retries use up (see the <<R.RETRY>> step).

NOTE: t min= 00000.0 sec ; t max= 99999.9 sec

(!) 00000.5

<<R.RETRY>> SET THE NUMBER OF THE COMMUNICATION RETRIES

The step allows to set the maximum number of communication retries, if the set number of retries use up, the communication still fails, the message "REM.DISCONNECT" (see section 4.2.5, **USER MAN.REF.**) is displayed and the dosage can't be executed.

NOTE: min= 000 ; max= 255

(!) 005

<< EN.KEYS >> KEYS ENABLING

It is possible to enable/disable each single key of the keyboard:

- select the desired key with F6/F7:

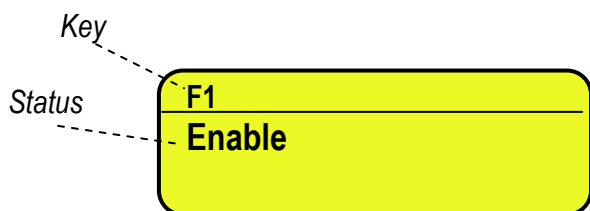

- press ENTER to modify the setting:

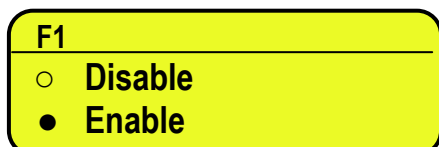

- Press F6/F7 to select “Enable” (enabled) or “Disable” (disabled), and ENTER to confirm.

NOTES:

- It's possible to enable/disable all the keys together, by selecting “ENABLE ALL” or “DISABLE ALL” (the confirmation will be requested with the message “SURE?”).
- The disabling of the keys will have effect only the WEIGHING PHASE, in other words, not inside the menus, databases, etc...
- The turning off of the instrument (long pressing of the C key) will always be enabled.
- The disabling of the keys will be applied also on the PC keyboard, if connected.

(!) **ENABLE ALL**

<< F.kEyS >> FUNCTION KEYS COUPLING

It's possible to modify the function of the F1, F2.....F10 keys, and the combination of these with the **2nd F** or **Fn** keys (i.e. “2nd F + F1”, “Fn + F2”, etc...).

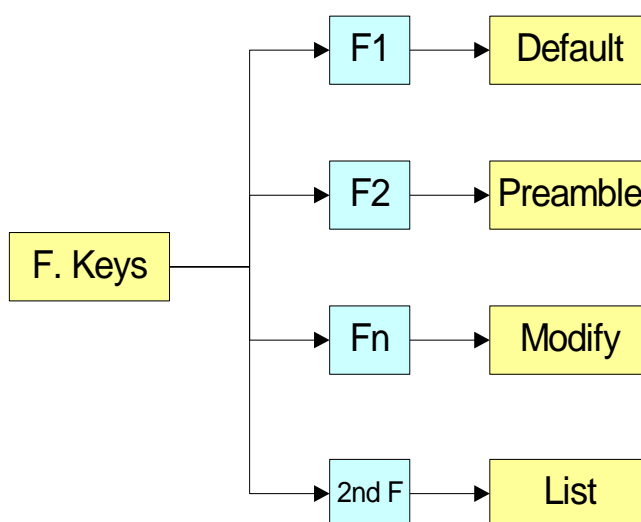

- select the desired key with F6/F7:

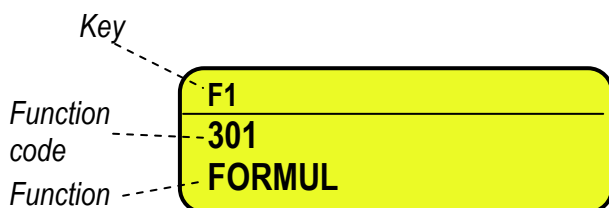

- press ENTER to modify the setting:



- Enter the desired code and confirm with ENTER.

By pressing numeric **999999** + **Fn** key it's possible to enter into the following menu:

CODE	BASIC FUNCTIONS	DEFAULT KEY/S
100	Scale zero (ZERO)	ZERO
101	Cyclic zero (0.CYCLE)	2ndF + ZERO
102	Tare execution (TARE)	TARE
103	Enable the printer (PRN-ON)	Fn + 0
104	Simple printout (PRINT)	F5
105	Repetition of last printout (CPY.PRN)	2ndF + F5
106	Change visualization weight (WEI.VIS)	2ndF + F8
107	CPWE: change visualization on display LCD (LCD.VIS)	2ndF + F10
108	Lock/unlock keyboard (L. KEYB)	F1 pressed at length
109	Visualization times ten (Disp.10)	F2 pressed at length
110	Set time and date (CLOCK)	F3 pressed at length
111	Diagnostics menù (Diag.)	F4 pressed at length
112	Lock/unlock tare (L. TARE)	F5 pressed at length
113	Input text configuration (txt)	F4
114	Calculator (CALC)	
118	Peripheral units diagnostics (P.DIAG)	
119	Com data diagnostics (COM.DAT)	
120	Custom display enabling (CST.DSP)	Fn +F9
121	Quick setting of the input text 0 (tXt.0)	
122	Quick setting of the input text 1 (tXt.1)	
123	Quick setting of the input text 2 (tXt.2)	
124	Quick setting of the input text 3 (tXt.3)	
125	Quick setting of the input text 4 (tXt.4)	
126	Quick setting of the input text 5 (tXt.5)	
127	Quick setting of the input text 6 (tXt.6)	
128	Quick setting of the input text 7 (tXt.7)	
129	Quick setting of the input text 8 (tXt.8)	
130	Quick setting of the input text 9 (tXt.9)	
131	Reset input texts (tXt.rSt)	
132	Send print format (Send.P.F)	
OTHER FUNCTIONS		
200	Coupling print formats (PRN.FMT)	
201	Coupling second format (SND.FMT)	
204	Selection channel 1 (PLT-1)	2ndF + 1
205	Selection channel 2 (PLT-2)	2ndF + 2
206	Selection channel 3 (PLT-3)	2ndF + 3

207	Selection channel 4 (PLT-4)	2ndF + 4
208	CPWE: change visualization on second line (DAT.VIS) 3590E: change visualization on first line (DAT.VIS)	2ndF + F9
209	Switch on the next channel (CHG.PLT)	2ndF + 2ndF
SPECIAL FUNCTIONS		
300	Phases database (PHASES)	F2
301	Formula database (FORMUL)	F1
302	Setting total weight (WGT.FOR)	F7
303	Setting number of dosage cycle repetition (N.CYCLE)	F8
304	Printing the report of all the activities (PRN.ACT)	
305	Print and clear the consumption of all the dosage activities (PRN.CON)	
306	Clear the consumption of all the dosage activity (CLR.CON)	
307	Printing the report of a specific formula (PRN.FOR)	
308	Printing the report of all the formulas (PRN.F.A)	
309	Print and clear the production of a specific formula (PRN.P.F)	
310	Print and clear the production of all the formulas (PRN.PRO)	
311	Print and clear general total (PRN.G.T)	F9
312	Clear the production of a specific formula (CLR.P.F)	
313	Clear the production of all the formulas (CLR.PRO)	
314	General total zeroing (CLR.G.T)	
315	Start dosage (START)	F6
316	Dosage pause (PAUSE)	F10
317	Direct insertion 1st target (D.INS.1)	
318	Direct insertion 2nd target (D.INS.2)	
319	Direct insertion 3rd target (D.INS.3)	
320	Direct insertion 4th target (D.INS.4)	
321	Direct insertion 5th target (D.INS.5)	
322	Direct insertion 6th target (D.INS.6)	
323	Formula selection with alphabetical research (FOR.SEL)	
324	Quick changing of the formula targets (TARGET)	F3
325	Printing the report of the selected formula (PR.A.FOR)	
326	Print and clear the production the selected formula (PR.P.A.F)	
327	Enable production program (EN.PROD)	
328	Set formulas in the production program (SET.PRD)	
329	Print last executed production program (PRN.PRD)	
330	General total data visualization (GEN.TOT)	
331	REMOTE FORMULA IN PROGRESS (REM.PRO)	
332	REMOTE INSTRUMENT TEST (REM.TST)	
333	COMMAND FORWARD TO PC PORT (CMD.FWD)	
PRINTOUT MENU VISUALIZATIONS		
400	Set progressive digit (Prg.1)	
401	Set progressive ticket (Prg.2)	
402	Reset progressive ticket (0.Prg)	

Preamble function

It is possible to associate also a preamble (numeric value) to the F1, F2...F10 keys: the preamble will be used as parameter of the function linked to the key, and allow to execute a specific function, depending on the main function itself, as described in the following list:

KEY FUNCTIONS	PREAMBLE FUNCTION	VALUE TO SET IN THE PREAMBLE
107 - Change visualization on second line (LCD.VIS)	Direct selection of a specific visualization on the second line.	Number of the desired visualization (see section 4.2.4, USER.MAN.REF.).
108 - Change visualization on first line (DAT.VIS)	Direct selection of a specific visualization on the first line.	Number of the desired visualization (see section 4.2.4, USER.MAN.REF.).
114 - Input text configuration (tXt)	Direct access to the modification of a specific input text.	Number of the input text that one wants to modify.
131 - Reset input texts (tXt.rSt)	Direct cancellation of the contents of an input text or all the input texts.	Number of the input text that one wants to cancel (see section 10, USER.MAN.REF.).
132 - Send print format (Send.P.F)	Direct sending of a specific print format on the serial port to print.	Number of the print format that one wants to send.
200 - Coupling print formats (Prn.Fmt)	Direct access to the modification of the coupling of a specific print function to a print format.	Number of the format on which one wants to modify the coupling.
301 - Formula database (Art.dtb)	Direct selection of a specific formula.	Number of the desired formula.
400 - Set progressive digit (Prg.1)	Direct selection of a specific digit	Number of the desired digit
401 - Set progressive ticket (Prg.2)	Direct selection of a specific ticket number	Number of the desired ticket

To set the preamble:

- select the desired key with **F6/F7**:

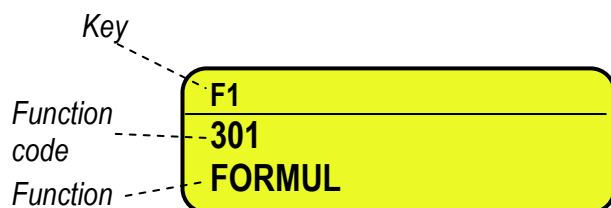

- press **F2** to insert the preamble, select enable and confirm with ENTER:

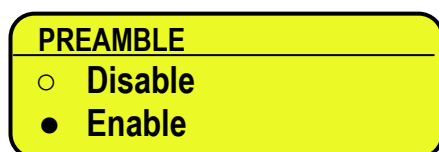

- enter the desired value through the numeric keyboard and confirm with **ENTER** (by confirming the value 0, the preamble is disabled).

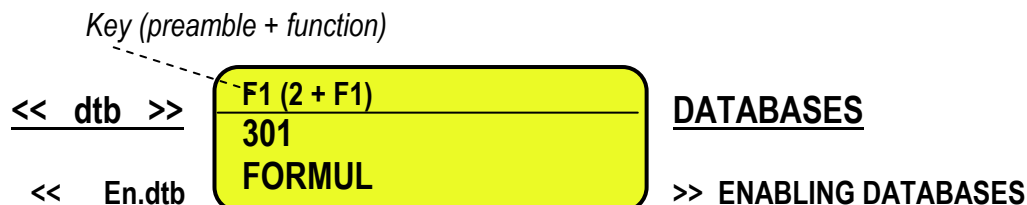
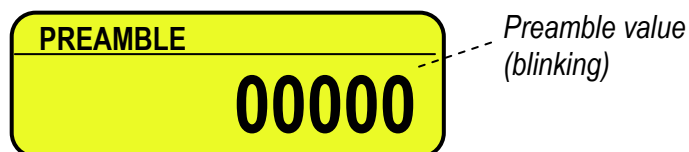

It's possible to enable or disable the activity and formula databases.

EnAbLE: databases enabled.

diSAbL: databases disabled.

(!) EnAbLE

<< En.A.Fld >> ARTICLE FIELD ENABLING

It's possible to enable one by one the fields necessary for the application.

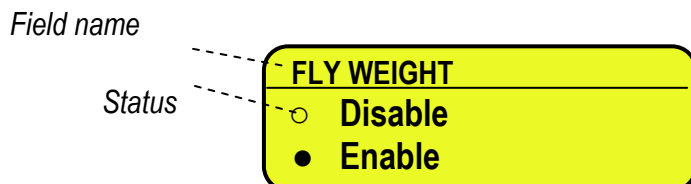

- Press F6/F7 to select "Enable" (enabled) or "Disable" (disabled), and ENTER to confirm.
- Proceed up to the last suggested field, after which it automatically exits the step.

NOTE: The description is always enabled.

<< U.M. >> DATABASE UNIT OF MEASURE

It is possible to set the unit of measure of the ACTIVITIES database and of FORMULAS database, in relation to the total values: kg, t, lb, g; if the unit of measure is different than the one of the active scale, the displayed or printed total value will be automatically converted with the database's unit of measure.

(!) kg

<< DECIM. >> DATABASE DECIMALS

It is possible to set the number of decimals of the ACTIVITIES database and of FORMULAS database, in relation to the total values: 1, 2, 3, no decimal; if the number of decimals is less than the one of the active scale, the displayed or printed total value will be automatically rounded off.

(!) x.xxx

<< INIT. >> INITIALIZE DATABASES and INPUT TEXTS

By pressing **ENTER** one initialises the DATABASES (with the total values), the number of decimals and unit of measure of the databases and the INPUT TEXTS: in this way all their contents will be cancelled.

The cancellation is not immediate; the indicator requests a further confirmation (the LCD display shows "RESET DATABASES ? ENTER=YES C=NO").

By pressing **ENTER** one confirms the operation, by pressing **C**, the indicator gives the possibility to **cancel all the databases individually** in this order: ACTIVITY DATABASE, FORMULA DATABASE, INPUT TEXTS.

<< rEAct >> REENABLING OF THE PRINTOUTS

It is possible to set the re-enabling of the simple print function in the following modes: "passage of the net weight by zero" or "weight instability".

PASS.0: passage of the net weight by zero

inStAb: instability

(!) **PASS.0**

<< rEstAr >> RESTORING TARE AND ZERO AT START-UP

It's possible to set whether to restore or not at start-up the active tare before turning off the instrument.

EnAbLE: restoring enabled tare and zero.

diSAbL: restoring disabled tare and zero.

See the section "7.8 RESTORING TARE AND ZERO AT START-UP" in the user manual for the functioning specifics.

(!) **EnAbLE**

<< LOGO >> TEXT UPON START-UP

At the start-up of the indicator, the LCD display shows a message of 2 lines of 16 characters, which is set in this step, or a 160x32 pixel photo uploadable from Dinitools™ ("*.bmp" monochromatic format is accepted).

(!)  **DINI ARGO**

<< tXt >> INPUT TEXTS**<< CFG.tXt >> INPUT TEXT CONFIGURATION**

Through this step one can enter, modify or cancel the heading of the input texts which will be filled in during the weighing through the F4 key of the indicator; refer to the user manual for further specifications. (**USER MAN.REF.**).

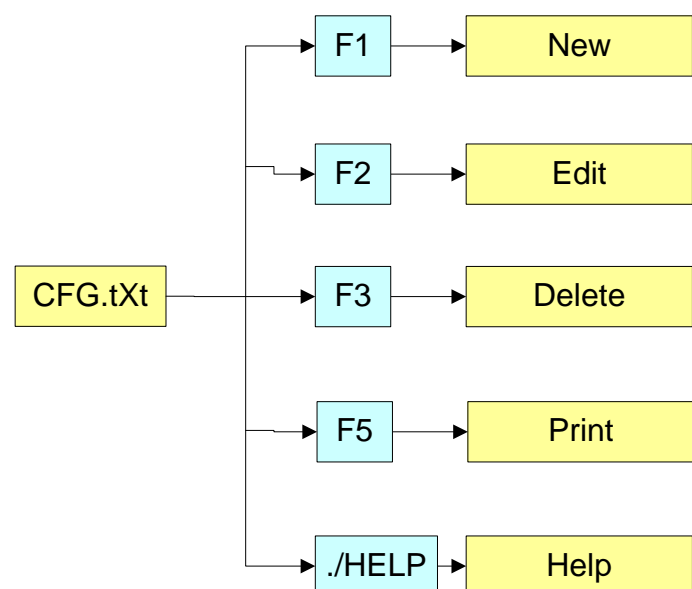

ENTRY

- Press **ENTER** to enter in the step.
- Select the eventual desired position through the arrow ▲ ▼ keys (or with the keyboard digit the position number).
- Press **F1** to enter the text in the desired position, or the first free position, if an already occupied position has been selected.
- The display shows "DESCRIPTION" and one can now enter the heading of the input text (up to 16 characters); press **ENTER** to confirm.
- The display shows "TEXT" and one can enter the contents of the input text (up to 32 characters); press **ENTER** to confirm.
- The display shows "THRESHOLD" and one can enter the maximum number of alphanumeric characters enterable in the field "TEXT"; press **ENTER** to confirm.
- The display shows "MANDATORY INPUT", if one chooses "Enable" it is possible to exit from the input phase only if the text isn't null; press **ENTER** to confirm.
- The display shows "ONLY VOID INPUT"; if one chooses "Enable" it is possible to modify the text only if it is null; press **ENTER** to confirm.

NOTE: The threshold entered here defines also the field length for the compilation through the **F4** key in the weighing phase; if no text is inserted, the length is set at 32 characters.

MODIFICATION

- Press **ENTER** to enter in the step.
- Select the storage to be modified through the arrow ▲ ▼ keys (or with the keyboard digit the position number) and press **F2**.
- Modify the desired fields, listed in the previous section.
- **NOTE:** The text entered here defines also the field length for the compilation through the **F4** key in the weighing phase; if no text is inserted, the length is set at 32 characters.

CANCELLATION

- Press **ENTER** to enter in the step.
- Select the storage to be cancelled through the arrow ▲ ▼ keys (or with the keyboard digit the position number) and press **F3**.
- The indicator requests a further confirmation: press **ENTER** to confirm or another key to cancel.

PRINTING

- Press **ENTER** to enter in the step.
- Once inside it, press the **F5** key to print all the input texts. The LCD display shows the message "PRINT ?": confirm with the **ENTER** key to print the whole input texts' database.

HELP

By pressing the **.HELP** key, it's possible to see the keys list used in the menu.

The key list is automatically. If you want to see the keys list, in manual mode, use the arrow key (**F6** or **F7** key).

<< d.thrES >> DATA LENGTH THRESHOLD FROM READER

If one enables the compilation function of the free texts through the bar code reader / badge (see relative manual), In this step one can define a length (from 00 to 31) which conditions the storage of data readed. If the datum has a length less or equal to the predefined one; it is stored in the first input text; otherwise it is stored in the second one.

NOTE: the function has been enabled on the serial port selected in the **SEtuP >> SEriAL >> rEAdEr** step, or on the PC KEYBOARD input, by selecting the "Reader" parameter in the **SEtuP >> PC.KEYb >> KEY.uSE** step.

<< tXt.i >> ENTRY OF HEADINGS

Up to 3 lines x 24 characters of text can be entered that will be printed if programmed in the printout formats. The text entered will remain stored and printed until it is either cancelled or substituted.

<< CLr.rAM >> BUFFERED RAM RESET

The indicator has a buffered RAM memory (not volatile when power is removed) inside which is the database data, the input texts, the print formats, the heading.

The cancellation is not immediate; the indicator requests a further confirmation: press **ENTER** to confirm or press another key to cancel.

Note: CALIBRATION DATA ARE NOT CANCELLED.

<< dtb.PWd >> SET DATABASE ACCESS PASSWORD

By confirming the **EnAbLE** setting one may insert a password of up to 5 digits, which will block the visualisation of the databases, after the pressing of the **ENTER** key during the weighing. By setting **diSAbl**, this password is disabled.

See the section "DATABASES ACCESS PASSWORD", in the "MENU KEY" section of the user manual.

NOTE: The maximum enterable value is **65534**.

(!) **diSAbl**

<< tAMAG >> TAMAGOTCHI

One enters the "NUMBER of MONTHS" passed (2 digits, **MonthS** paramters), and the "NUMBER of the WEIGHS" made (5 digits, **WEiGh**. parameter) **since the last calibration**; after this, one is advised to recalibrate the instrument.

By pressing **ENTER** one passes to a submenu:

- **MonthS** >>> Setting of Months
- **WEiGh**. >>> Setting of Weighs
- **rESEt** >>> Clearing of Months and Weighs from the last calibration

If you set the number of months and the weighing to zero, this function will be disabled; in any case it is possible to activate a choice of the number of months (MAX 99) or the number of weighs (MAX 99999).

By confirming with **ENTER** on the "rESEt" step one sets at zero the number of months and weighs taken place since the last calibration made.

At start-up and every day at 11:00 o'clock, the indicator will be checking for the number of weighing and the number of months that have passed since the last calibration. If one of the values or both are equal or higher than the previously set values, "WE ADVISE TO RECALIB. SCALE" appears in the display. By pressing any key, the indicator will enter in the normal scale functioning mode.

(!) **MonthS 00; WEiGh. 00000.**

<< SEtuP >> SCALE CONFIGURATION**<<ConFiG>> PARAMETERS (*)**

NOTE: in case of various connected scales, one will be asked to select the scale that is to be calibrated.

<<PArAM>> PARAMETERS**(*) <<StAbiL>> FILTERING INTEGRATION**

By pressing the **ENTER** key one accesses the selection of the type and degree of filter intervention for the stability of the weight indication:

- FLt 0 – 3** filter for simple weighing
- h.r.0 – 1** filter for high resolution
- dYn.0 – 1** filter for weight in movement (i.e. weighing animals)
- doS.0 – 3** filter for dosage
- SLW.0 – 3** filter for weight rather unstable
- h.r.2 – 7** filter for high resolution
- dYn.2 – 3** filter for weight in movement (i.e. weighing animals)

(*) In case of approved instrument, one can select only: **FLt 0...3, h.r.0, h.r.1, dYn.0, dYn.1.**

The higher the filter value, and greater is its intervention relative to the type of filter used.

(!) **FLt 3**

<< (*) Auto-0 >> AUTOZERO AT START-UP

Automatic acquisition of the gross zero at start-up.

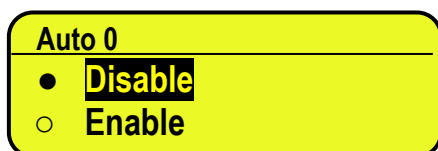

- Disabled

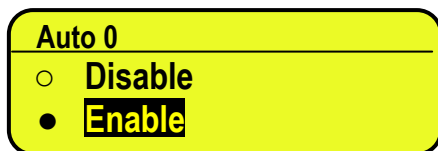

- Enabled

ENTER →

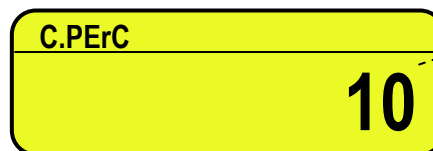

Clearing percentage
(blinking)

Set the clearing percentage in relation to the capacity (in between +/-1 and +/- 50 %).

See section 3.2 (**USER MAN.REF.**) for details on the functioning.

(*) with approved instrument:

- it's not possible to change the selection from EnAbLE to diSAbLE or vice versa.

- by confirming the setting of EnAbLE it is possible to modify the clearing percentage between +/-1 and +/-10 %.

(!) EnAb, +/-10 %

<< (*) 0-PErC >> ZERO FUNCTIONS IN WEIGHING PHASE

Acquisition of the gross zero through the ZERO key or through the AUTOZERO function.



Clearing percentage
(blinking)

Set the clearing percentage in relation to the capacity (in between +/-1 and +/- 50 %).

By entering the 0 value, it's possible to disable the ZERO functions in the weighing phase.

See section 6 (**USER MAN.REF.**) for functioning details.

(*) In case of approved instrument, the settable values are between 0 and 2.

(!) +/-2 %

<< (*) WArMuP >> HEATING PHASE

It is possible to set a time in which, during the start-up phase, a short preheating is made of the instrument electronics, in order to optimize the weighing.

The 00 value disables the function.

(*) The function has no effect if <<Auto-0>> is diSAbL.

NOTE: tMin = 00 sec.; tMax = 60 sec.

(!) 00

<< (*) 0.trACK >> ZERO TRACKING

This allows setting the zero tracking, in other words, the compensation parameter of the scale's thermal drift. The set value corresponds to the number of **stable divisions per 1 second** that one desires to compensate.

tr. ½	+/- half division.
tr. ¼	+/- one fourth of a division
tr. 1	+/- one division.
tr. 2	+/- two divisions.
tr. no	tracking disabled.

(*) In case of approved instrument, by entering the step one views the set value; by pressing **ENTER** it's possible to modify the parameter and choose one of the following values: **tr. no**, **tr. ½**, **tr. ¼**.

(!) tr. ½

<<(*) diV.Stb>> DIVISIONS BY STABILITY

In this step one enters the number of divisions by which the instrument detects the weight stability; the higher the number of divisions, less is the sensitivity, and consequently the stability is more easily detected. The possible values are 0...99.

NOTE: the 0 value disables the checking.

(*) In case of approved instrument the parameter is read only.

(!) **02**

<< (*) GrAV>> GRAVITY ZONE AND ZONE OF USE

In this step one selects the gravitational acceleration value **of calibration and of use** of the instrument:

Manual entry of the g value: the instrument is ready for the manual entry of the gravitational acceleration value.

If one enters a wrong g value: the minimum decimal value is proposed (9,75001); by a wrong g value one intends a decimal number not including between 9,75001 and 9,84999 (included).

(*) In case of approved instrument the parameter is read only.

(!) **g = 9,80655**

<<(*) CALib.>> SCALE CALIBRATION

See section "4. CALIBRATION"

(*) In case of approved instrument the parameter is read only.

<<(*) 0.CALib.>> ZERO CALIBRATION

See section "4. CALIBRATION"

(*) In case of approved instrument the step is not visible.

<<SERIAL>> SELECTION OF THE SERIAL OUTPUT PARAMETERS**<< PORTS >> SERIAL CONFIGURATION**

By pressing ENTER it's possible to choose the most adequate combination for the use of the three serial ports on the indicator hardware (**COM1, COM2, COM3**):

Parametro	COM 1	COM 2	COM 3
PC.PR.AX (!)	ComPC	ComPrn	ComAux
PC.AX.PR	ComPC	ComAux	ComPrn
PR.PC.AX	ComPrn	ComPC	ComAux
PR.AX.PC	ComPrn	ComAux	ComPC
AX.PC.PR	ComAux	ComPC	ComPrn
AX.PR.PC	ComAux	ComPrn	ComPC

<<CoMPrn>> PRINTER SERIAL PORT**<<bAud>> SET BAUD RATE**

By pressing the **ENTER** key one accesses the selection of the data transmission speed (measured in Baud = bit/second). The possible values are: 1200, 2400, 4800, 9600, 19200, 38400, 57600, 115200.

(!) **9600**

<<PARitY>> SET PARITY BIT

By pressing the **ENTER** key one accesses the selection of the parity bit type. The possible values are: nonE (absent parity bits), odd (uneven parity bits) e EVEn (even parity bits).

(!) **nonE**

<<Word>> SET WORD LENGTH

By pressing the **ENTER** key one accesses the selection of the number of data bits. The possible values are: 8 (8 data bits) and 7 (7 data bits).

(!) **8**

<<StoP b>> SET STOP BIT

By pressing the **ENTER** key one can then select the number of stop bits. The possible values are: 1 (1-stop bit) and 2 (2 stop bits)

(!) 1

<<CtS.St.>> SET CTS LEVEL

On the serial line set as COM.PRN the indicator can manage a synchronism signal.

- by using the dedicated CTS (Clear To Send) signal, if one uses the COM2 port, or

- by using the RX input, if one uses the COM1 or COM3 port (in this case, by enabling the function, this input will be no longer managed for other reception functions).

A device (like a printer) that is slow in processing the data received, can interrupt the transmission temporarily using this signal.

It is possible to select:

no.CtS no signal (ITALORA WITTY280 and SMT280)

LoW CTS active low (LP522/542, EPSON LX300, TM295, TPR, LP542PLUS, TTP243, LP542S, SMTPLUS)

hiGh CTS active high (DP190)

EMuCtS Emulation of CTS signal, one is asked to enter the number of characters (nChrS) using 3 digits, which will be transmitted upon each transmission; then one should enter the wait time in milliseconds (tiME), using 4 digits, from a transmission and the next one.

(!) no.CtS

<<SND.CTS>> SECOND CTS SIGNAL (§)

This step decides if enable (**ENABLED**) second CTS signal used for 2 printers or not (**DISABLED**). See the previous step **<< CtS.St. >>**.

(§) the step is visible only if **COM2** is set on "**PRN**" and **LOW** or **HIGH** signal is enabled inside "**CtS.St.**" step.

(!) **DISABLED**

<< Err.CtS >> CTS STATUS ERROR

By enabling this error, it is possible to block in advance the print or totalisation function, if recalled with an already active synchronism signal (see previous step): the indicator display will shows the message "PRINTER ERROR: CHECK THE CTS!" for a few seconds and return to the weighing phase without carrying out the function.

Press F6/F7 to Enable (enabled) or Disable (disabled), and ENTER to confirm.

(!) **Disable**

<<PWrPrn>> PRINTER POWER SUPPLY

On the indicator board there is a terminal board called V-AUX (auxiliary power supply), thanks to which it is possible to power the devices (for example a printer); refer to the electric scheme for the characteristics.

In this step one programmes the functioning of the auxiliary output and the management of a possible connected printer:

PWr.EXt with instrument on, printer managed and auxiliary output always active.

PWr.int printer managed, auxiliary output active only when the instrument executes a printout.

Ext.oFF printer managed and auxiliary output always active; the start-up characters are sent to the printer, because the printer is considered to be configured in the energy saving mode.

(!) **PWr.Ext**

<<ProtoC>> SELECTS PROTOCOL

norMAL Print

riPE 6 protocol for 6-digit repeater.

Cont. continuous transmission

For the protocol specifications, see 8.4 section.

(!) **norMAL**

<<CoM PC>> PC SERIAL PORT CONFIGURATION**<<bAud>> SET BAUD RATE**

By pressing the **ENTER** key one accesses the selection of the data transmission speed (measured in Baud = bit/second). The possible values are: 1200, 2400, 4800, 9600, 19200, 38400, 57600, 115200.

(!) **9600**

<<PARitY>> SET PARITY BIT

By pressing the **ENTER** key one accesses the selection of the parity bit type. The possible values are: nonE (absent parity bits), odd (uneven parity bits) e EVEn (even parity bits).

(!) **nonE**

<<Word>> SET WORD LENGTH

By pressing the **ENTER** key one accesses the selection of the number of data bits. The possible values are: 8 (8 data bits) and 7 (7 data bits).

(!) **8 b**

<<StoP b>> SET STOP BIT

By pressing the **ENTER** key one can then select the number of stop bits. The possible values are: 1 (1-stop bit) and 2 (2 stop bits)

(!) **1**

<<CtS.St.>> SET CTS LEVEL

On the serial line set as COM.PRN the indicator can manage a synchronism signal.

- by using the dedicated CTS (Clear To Send) signal, if one uses the COM2 port, or

- by using the RX input, if one uses the COM1 or COM3 port (in this case, by enabling the function, this input will be no longer managed for other reception functions).

A device (like a printer) that is slow in processing the data received, can interrupt the transmission temporarily using this signal.

It is possible to select:

no.CtS no signal (ITALORA WITTY280 and SMT280)

LoW CTS active low (LP522/542, EPSON LX300, TM295, TPR, LP542PLUS, TTP243, LP542S, SMTPLUS)

hiGh CTS active high (DP190)

EMuCtS Emulation of CTS signal, one is asked to enter the number of characters (nChrS) using 3 digits, which will be transmitted upon each transmission; then one should enter the wait time in milliseconds (tiME), using 4 digits, from a transmission and the next one.

(!) **no.CtS**

<<Add.485>> 485 ADDRESS

By pressing the **ENTER** key one accesses the insertion of a code of 2 digits (from 00 to 98) which identify the instrument among those connected in the RS485 transmission mode, on the PC serial port.

NOTE: the 99 code is used as a broadcast address.

(!) **00**

<<ProtoC>> TRANSMISSION PROTOCOL

Here one decides the data transmission format of the PC serial line:

StAnd	Standard
AFXX	AFOX
riPE 6	Dini Argeo 6-digit repeater
Mondir	Uni-directional
CoMPoS:	Composite repeater

For the protocol specifications, see 8.4 section.

(!) **StAnd**

<<PC ModE>> TRANSMISSION TYPE

rEquE.	On request
Cont.	Continuous
StAbiL	A stabilità
- 485 -	485 mode

For the transmission mode specifics, see section 8.5.

(!) **rEquE.**

<< CoMAuX >> AUX SERIAL CONFIGURATION (§)**<< bAud >> SET BAUD RATE**

By pressing **ENTER** one can select the data transmission speed (measured in Baud = bit/second). The possible values are: 2400, 4800, 9600, 19200, 38400, 57600, 115200.

(!) **9600**

<< PAritY >> SET PARITY

By pressing **ENTER** one can select the parity bit type. The possible values are: nonE (absent parity bit), odd (uneven parity bit) and EVEEn (even parity bit).

(!) **nonE**

<< Word >> SET WORD

By pressing **ENTER** one can select the number of data bits. The possible values are: 8 (8 data bits) and 7 (7 data bits).

(!) **8**

<< StoP b >> SET STOP BIT

By pressing **ENTER** one accesses the selection of the stop bit number. The possible values are: 1 (1 stop bit) and 2 (2 stop bits).

(!) **1**

<< CtS.St. >> SYNCHRONISM SIGNAL

Not used in this application.

<< ProtoC >> SELECTS PROTOCOL

nonE	no protocol
Cont.	continuous transmission protocol
riPE 6	protocol for 6-digit repeater.

For the protocol specifications, see 8.4 section.

(!) **nonE**

<< r71.rEP >> R71 REPEATER

If the R71620 is connected to the indicator, through this step, it is possible to enable the dedicated protocol on the serial ports on which the "riPE 6" protocol is enabled.

Disable	Disable
Enable	Enable

(!) **Disable**

<< Prn.FMt >> PRINT CONFIGURATION

Through this step one can configure up to 30 print formats directly from the indicator.

In this step it is possible to choose the number of format to be configured; therefore enter, modify or eliminate the print blocks following the instructions shown in section **10 PROGRAMMING THE PRINTOUTS**.

<< tErMin >> SET TERMINATOR TYPE

When connecting a printer it is often necessary to transmit one of the following protocols in order to define the end of the print line.

Cr CR (for DP190, LP522/542,TPR)

Cr LF CR LF (for EPSON LX300 and TMU295)

LF LF

no.tErM NO TERMINATOR (for LP542 Plus, TTP243 and ITALORA COMPATIBLE, LP542S,SMTPLUS)

(!) CF

<< dEF.Prn >> PRINTOUT DEFAULT

By pressing **ENTER** one is asked to confirm the activation of the 30 default printouts: the display shows "SurE?": press **ENTER** again to confirm or another key to cancel the operation.

The printout default is configured only for TPR printer.

WARNING: By enabling the printouts, all the formatted print formats will be CANCELLED and the first 27 will be SUBSTITUTED by the default formats which automatically will be linked to the 27 print functions.

<<Anout>> ANALOGUE OUTPUT (OPTIONAL)

If various scales are connected independently (see **nuM.SCA** parameter), the scale number to be configured will be requested; the configurations inside this menu must be made for each connected scale.

See the "10. ANALOGUE OUTPUT (OPTIONAL)" section for configuring it

<< SLoT >> SLOT SELECTION

One selects the SLOT to be used with the analogue output: SLOT 1 or SLOT2.

<< ModE >> OPERATING MODE

AO G = analogue output on the gross weight

AO n = analogue output on the net weight

AO S = analogue output proportional on the dosage speed.

<< (§) AoMA >> MAXIMUM VALUE

Setting of the maximum value of the analogue output.

<< (§) AoZE >> ZERO SCALE VALUE

Setting of the analogue output value when the scale displays zero weight.

<< (§) AoMi >> MINIMUM VALUE

Setting of the minimum value of the analogue output.

<< OUTPUT. >> OUTPUTS CONFIGURATION

The indicator has 4 outputs on the main board and 12 outputs on the expansion board; through this step one can configure the functioning of 4 outputs (RL.1 to RL.4).

<< R.CONF. >> OUTPUTS CONFIGURATION

In this step it is possible to configure the functioning mode for the 4 outputs.

rL. 1 OUTPUT 1(OUT1)

<< RLFUNC >> RELAY FUNCTION

NULL NO FUNCTION (disabled)

END.DOS End dosage (activated when the dosage is finished)

FAST Fast speed (activated when the dosage is in approximate mode)

ERROR Error (activated when the dosage is in error condition)

OUT.TOL Out tolerance (activated when the dosed weight is out of tolerance, if <<TST.TOL>> is enabled)

OK.TOL In tolerance (activated when the dosed weight is within tolerance, if <<TST.TOL>> is enabled)

MIN.LVL Min level (activated when the weight goes below the minimum level threshold set in <<MIN.LVL>> step)

MAX.LVL Max level (activated when the weight exceeds the maximum level threshold set in <<MAX.LVL>> step)

OVER.T Over target (activated when the dosed weight exceeds the set target)

The same configurations are valid for:

rL. 2 OUTPUT 2(OUT2)

rL. 3 OUTPUT 3(OUT3)

rL. 4 OUTPUT 4(OUT4)

(!) RL.1 END.DOS, RL.2 FAST, RL.3 ERROR, RL.4 OVER.T

<< t.LoCK >> TARE LOCKED/UNLOCKED

EnAbLE LOCKED TARE

diSAbl UNLOCKED TARE

See the section "7.5 TARE LOCKED/UNLOCKED" in the user manual for the functioning specifics.

(!) EnAbLE

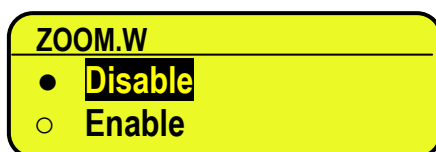
<< ZOOM.W >> WEIGHT ZOOM

- Disable

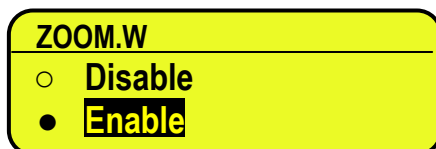

- Enable

ENTER →

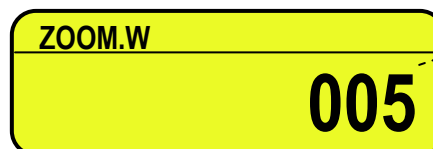

Activation delay
(blinking)

Insert the activation delay (included between 0 and 255 sec.).

See section 4.2.1 (USER MAN.REF.) for the functioning details.

(!) Enable, 005 sec.

<< PoW.oFF >> AUTO SWITCH OFF

One enables/disables the auto switch-off after the scale is not used for 5 minutes, with plate unloaded.

EnAbLE auto switch-off ENABLED

diSAblE auto switch-off DISABLED

(!) disable

<< bt.StAt >> BATTERY LEVEL INDICATION

One selects whether to enable or disable the software check of the battery charge level: each time that the charge goes down of level, it is notified through the symbols on the display. See section 4.2.3, **USER MAN.REF.**

EnAbLE check ENABLED

diSAbL check DISABLED

NOTE: by enabling the indication of the battery level, the backlight automatically switches off when there is no keyboard activity for at least 15 seconds.

(!) **diSAbL**

<< baCkuP >> INSTRUMENT DATA BACKUP

By pressing **ENTER** the indicator display shows "SURE?": press the **ENTER** to confirm or **C** to cancel the operation. In the first case, one is asked to enable or not a password.

If you confirm with **ENTER** key you enter to a submenu(**BAK.PWD**) wherein it is possible **ENABLE/DISABLE** the BACKUP password.

Default password is "00000". The password will required every whenever you want make another backup of instrument, where is also possible disable, enable and change it.

In the default steps (standard default, technical default, clearing of buffered ram, prints default or keys default), if a backup of the data is present and the password is enabled, one is asked to insert a correct password before execution of the normal default by pressing the **ENTER** key, or directly restore the saved data by pressing the **F1** key.

<< dFLt >> STANDARD DEFAULT

By pressing **ENTER** the indicator activates the default parameters, (shown in bold and preceded by the exclamation point at the end of each step) and the standard printouts; the display shows **SurE?**: press **ENTER** to confirm or **C** to cancel the operation.

NOTE: THE CALIBRATION, THE DATABASES, THE INPUT TEXTS and the HEADING ARE NOT CANCELLED.

<< (*) dFLt.t >> TECHNICAL DEFAULT

By pressing **ENTER** the indicator activates the default parameters (shown in bold and preceded by an exclamation point at the end of each step), the standard printouts, initialises the database, cancels the input texts, the heading and **THE CALIBRATION**; the display shows **SurE?**: press the **ENTER** key to confirm or **C** to cancel the operation.

(*) In case of approved instrument the step is not accessible.

<< PWd.SET >> SET ACCESS PASSWORD TO SET-UP ENVIRONMENT

One configures whether to enable or disable the access password to the technical menu:

EnAbLE password ENABLED

diSAbLe password DISABLED

By selecting **EnAbLE**, the instrument predisposes itself for the password entry, made up of up to 5 digits; when finished entering confirm with **ENTER**.

The enterable value are from 0 to 65534

See section 3 for the functioning specifics.

(!) **Disable**

<< (*) d.SALE >> LIMITATION OF THE SCALE FUNCTIONS

- **no** limitations disabled

- **yES** limitations enabled

(!) **no**

If limitations enable, the next step is shown:

<< REM.DSP >> PRESENCE OF THE REMOTE DISPLAY

- **no** remote display not present

- **yES** remote display present

(!) **no**

Refer to the user manual for the description of its functioning (**USER MAN.REF.**).

(*) In case of approved instrument the parameter is not accessible.

<< PC.KEYb >> PC KEYBOARD CONFIGURATION**<< KEYuSE >> KEYBOARD PORT USE**

norMAL Use of the external PC keyboard (see in the user manual the section 4.1.5.
rEAdEr Enabling data reception from external reader (See relative manual).
 (!) **normal**

<< LAYout >> EXTERNAL PC KEYBOARD LANGUAGE

uS.En american /english
dEut german
FrAn french
itAL Italian
 (!) **uS.En**

<< SOUND >> INSTRUMENT SOUND ENABLING

Disable instrument sounds disabled
Enable instrument sounds enabled
 (!) **Enable**

<< diAG. >> DIAGNOSTICS MENU

It's a submenu inside of which it is possible to check the software and hardware components of the scale, accessible also during the weighing, keeping the **F4** key pressed at length.

<< PrG.VEr >> FIRMWARE

Software version checking.

<< WEiGht >> WEGHT

By pressing **ENTER** the display shows:

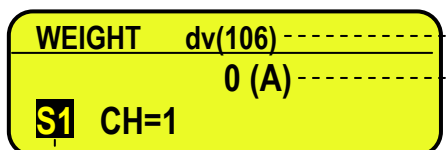

The display shows a yellow background with black text. At the top, it says 'WEIGHT' followed by 'dv(106)' and a dashed line. Below that is '0 (A)'. At the bottom, it says 'S1 CH=1'. To the right of the display, there are three lines of text: 'converter points per division', 'weight and type of cells', and '(A)=Analogue (D)=Digital'. Dashed lines connect the text to the corresponding parts of the display.

Checked scale

If various scales are connected independently by pressing the **F6 / F7** keys it is possible to select the scale to be checked.

<< MiLLiV >> MILLIVOLT

Check of the load cell signal in millivolts, in three decimals.

By pressing **ENTER** the display shows:



The display shows a yellow background with black text. At the top, it says 'MILLIVOLT'. Below that is '0.285 (A)'. At the bottom, it says 'S1 CH=1'. To the right of the display, there is a line of text: 'Millivolt and type of cells: (A)=Analogue, (D)=Digital'. Dashed lines connect the text to the corresponding parts of the display.

Checked channel

If various scales are connected independently by pressing the **F6 / F7** keys it is possible to select the scale to be checked.

In the case the load cell is not connected or faulty, or the A/D converter is faulty, it is possible that floating values are shown, or the message "Err.C.XX" appears (in which XX is the number of channel / digital load cell on which the faulty is detected), if the signal exceed the underload / overload value of the converter.

To check if the A/D converter is faulty, disconnect the channel on which the faulty is detected and make a short between SIG+ and SIG-; with non faulty A/D converter a mV value proxime to 0.000 will be displayed.

<< **ADC.Pnt >> CONVERTER POINTS**

Check of the A/D converter points.

By pressing **ENTER** the display shows:

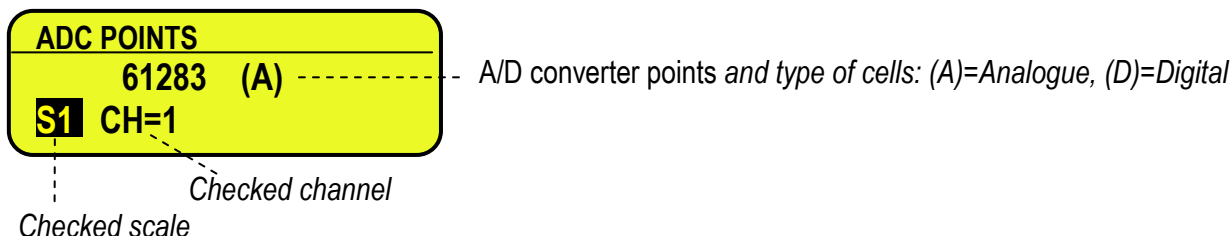

If various scales are connected independently by pressing the F6 / F7 keys it is possible to select the scale to be checked.

In the case the load cell is not connected or faulty, or the A/D converter is faulty, it is possible that floating values are shown, or the message "Err.C.XX" appears (in which XX is the number of channel / digital load cell on which the faulty is detected), if the signal exceed the underload / overload value of the converter.

To check if the A/D converter is faulty, disconnect the channel on which the faulty is detected and make a short between SIG+ and SIG-; with non faulty A/D converter a number of point proxime to 0 will be displayed.

<< **diSPLAY >> DISPLAY**

By pressing **ENTER** the instrument shows the display version.

By pressing a key the display pixels turn on for some seconds, after that the indicator exit automatically from the step.

<< **kEyb. >> KEYBOARD**

By pressing **ENTER** the instrument displays 0; by pressing the keys one at a time, the relative codes are shown to the display. One exits pressing the same key three times

<< **CtS.St. >> CTS STATUS**

By pressing **ENTER** the CTS signal type of the connected printer is shown on the display.

<< **B.Level >> BATTERY LEVEL**

By pressing **ENTER** one views on the display the value of the battery input on the motherboard, read by the analog-digital converter.

<< **Power >> POWER SUPPLY VOLTAGE**

By pressing **ENTER** the display shows the value of the power adapter input on the motherboard, read by the analogue-digital converter.

<< **rELE >> RELAY TEST**

By pressing **ENTER** it is possible to test all the available relays; by selecting these one at a time with the ▲ ▼ arrow keys, these are activated:

RL.01	OUT1	
...		Relay of the main board.
RL.04	OUT4	
RL.05	OUT5	
...		Relay of the expansion board (optional).
RL.16	OUT16	

<< inPutS >> INPUT TEST

By pressing **ENTER** it's possible to test the status of the inputs; the display will show:

INPUTS							
1	2	3	4	5	6	7	8
0	0	0	0	0	0	0	0

in which the number on the first line identifies the input:

1	IN1	
...		Inputs of the motherboard
3	IN3	
4	IN4	
...		Inputs of the expansion board
8	IN8	

and the number each input corresponds to its status:

0 = disabled;
1 = enabled.

<< Anout >> ANALOGUE OUTPUT TEST

If the instrument is fitted with the optional analogue output, through this step one can test if the values of the D/A converter (to be entered at time of calibration) correspond with the relative values of the analogue output (in voltage or in current), see section 9.

By pressing **ENTER** the display shows 00000; enter a value between 00000 and 65535 and confirm with **ENTER**; the instrument will supply the corresponding analogue value in output.

To exit the test confirm twice with **ENTER** the same entered value.

<< SEr. >> SERIAL PORTS TEST

By pressing **ENTER** it's possible to redirect the data received by any serial port, on other serial ports.

<< SEr.nuM >> SERIAL NUMBER

Diagnostics check for use of the manufacturer.

<< P.TEST >> PRINT FORMAT TEST

By pressing **ENTER** one is firstly asked to insert print format number to be tested, and then press **ENTER** again, the display shows "FMT.XX PRINT..." (XX indicates print format number), while the instrument will automatically print the format.

<< EV.LOG >> INSTRUMENT EVENTS VIEWER

By pressing **ENTER** it's possible to select the following events type:

- METRIC EVENT view metric information, such as calibration, equalisation
- BATTERY EVENT view the battery on/off status and level change
- KEYBOARD EVENT view the pressed keys information
- SETUP EVENT view the SETUP change and technical default information
- FW UPDATE EVENT view the firmware update information

For each event the last 10 information are stored with the date/hour.

During view of the events, by pressing the F5 key it's possible to print the information.

4. CALIBRATION

The instrument offers the possibility of using the 4 channels of the A/D converter in order to obtain 4 independent weighing systems (therefore "independent channels"). Each connected system must be calibrated on its own, with its own capacity, division, and unit of measure.

4.1 CALIBRATION PROCEDURE

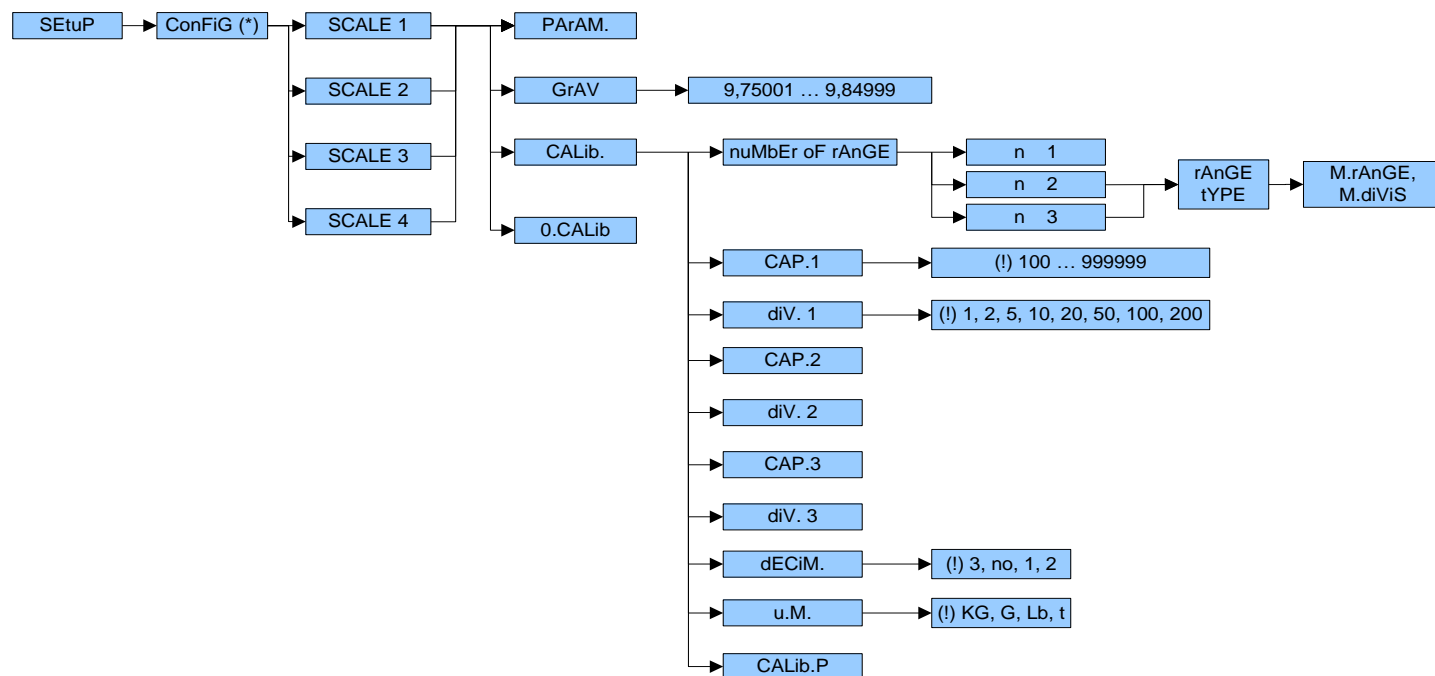

- 1) Enter in the SET-UP environment of the scale (when switched on, press for an instant the **TARE** key during the countdown).
- 2) Set the number of used channels; enter in the <<nuM.SCA>> step and select with the ▼ ▲ arrow keys:
 - n.SC. 1
 - n.SC. 2
 - n.SC. 3
 - n.SC. 4
- 3) Select the <<SEtuP>> step and press **ENTER**;
- 4) Select the <<ConFIG>> step and press **ENTER**;
- 5) Select the scale to be configured with the ▼ ▲ keys (only if nuM.SCA > 1) and press **ENTER**.
- 6) Select the <<GrAV>> step and press **ENTER**;
- 7) Select the calibration gravity zone or set the gravity acceleration value and confirm with **ENTER**.
- 8) Select the <<CALib.>> step and press **ENTER**;
- 9) Select the number of calibration range and confirm with **ENTER**
 - if there is only one measuring range, select 1;
 - with various fields (up to 3), the type of scale will be requested: select M.rAnGE (if a multirange scale) or M.diViS (if a multidivisional scale) and confirm with **ENTER**.

- 10) Select the <<**CAP.1**>> step and press **ENTER**;
Set the total capacity of the scale or the first range in case of n ranges and press **ENTER**.
TAKE NOTE: enter the whole value including the decimal digits; for example if the capacity should be over 6 kg and the division 0.001kg (= 1 g), set 6000, or if the capacity should be 1500 kg and the division 0.5 kg, set 15000.
(!) 000.100
- 11) Select the <<**diV. 1**>> step and press **ENTER**;
Set the minimum division of the scale or the first range in case of n ranges and press **ENTER** (selectable values: 1, 2, 5, 10, 20, 50, 100, 200).
(!) 1
- 12) Select step <<**CAP.2**>> (only in the case of n ranges) and press **ENTER**;
Set the capacity of the second range and press **ENTER**.
- 13) Select step <<**diV. 2**>> (only in the case of n ranges) and press **ENTER**;
Set the minimum division of the second range and press **ENTER**.
- 14) Select step <<**CAP.3**>> (only in the case of n ranges) and press **ENTER**;
Set the capacity of the third range and press **ENTER**.
- 15) Select the step <<**diV. 3**>> (only in the case of n ranges) and press **ENTER**;
Set the minimum division of the third range and press **ENTER**.
- 16) Select the step <<**dECiM.**>> and press **ENTER**;
Set the decimals and press **ENTER** (selectable values: 1, 2, 3, no decimal).
(!) 0.000
- 17) Select the <<**u.M**>> step and press **ENTER**;
Set the unit of measure (g, lb, t, kg) and press **ENTER**.
(!) kg
- 18) Select the <<**CALib.P**>> step and press **ENTER**.
- 19) Set the number of points on which one wants to calibrate (from 1 to 8, with 1 one will do the zero point and the weight point) and press **ENTER**.
N.B.: the calibration points must be increasing (point 1 < point 2 < point 3 etc..).
- 20) One is asked the zero scale point: unload the scale and wait a few seconds, then press **ENTER**.
- 21) If the zero scale has been done well, one is asked for the first sample weight.
- 22) Put the weight on the scale, on the indicator set the value of the weight put on the scale, and press **ENTER**.
- 23) In case of various points restart from the previous point.
- 24) If one needs to calibrate various scales, once the calibration is made of all the necessary points, press many times the **C** key until the indicator shows on the display the scale which one is calibrating (for example "SCALE 1").
Select another scale and repeat the operations from point 6) onwards.
- 25) Once the calibration is made, press many times the **C** key until the indicator shows "EXITING SETUP: SAVE?" in the display: confirm with **ENTER** to store and return to weighing.

4.2 LINEARISATION POINTS

By entering in the **SEtuP** >> **ConFiG** >> **CALib** >> PointS step it's possible to access a menu which allows to view/modify the linearization points of the last calibration made:

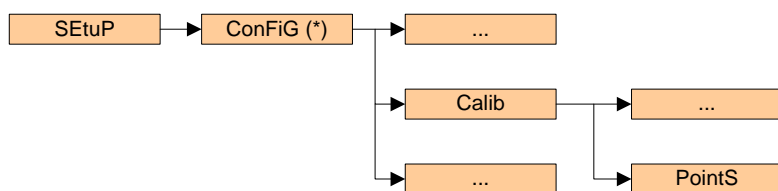

POINT	ADC.POINT	WEIGHT
0	72461	0.000
ACT. 1	182567	1.000

POINT	ADC.POINT	WEIGHT
1	182567	0.000
ACT. 2	279939	1.890

...		
...		
...		

POINT	ADC.POINT	WEIGHT
8	XXXXXX	XXX.XXX
ACT. 8	XXXXXX	XXX.XXX

KEYS' FUNCTIONS

- F1** inserts a linearization point
- F2** deletes a linearization point.
- F3** copies a linearization point (waiting stability).
- F4** copies ADC.POINT data (waiting stability).
- F5** quickly copies ADC.POINT data (without waiting stability).
- F6** scrolls forward the points.
- F7** scrolls backward the points.
- F8** moves cursor from right to left to select parameter, and press **ENTER** key, one is asked to enter desired value.
- F9** moves cursor from left to right to select parameter, and press **ENTER** key, one is asked to enter desired value.
- 2nd F** switches from points to mV or vice versa.
- HELP** shows the keys function.
- ENTER** modifies a point (weight and converter points); while entering it confirm the values.
- C** exits the programming; one is asked to save (the display shows "ACTIVATE NEW CALIBATION ?"): with **ENTER** one confirms, with another key one exits without saving. While entering a code, it quickly zeros the present value.

4.3 ZONE OF USE DIFFERENT FROM THE CALIBRATION ZONE

In case the zone of use is different from the calibration zone one should:

- 1) Execute the calibration, following the procedure shown in section 4.1.
- 2) Enter in the Set-up of the instrument;
(upon start-up, press for an instant the **TARE** key while the instrument version is displayed)

- 3) Enter in the configuration menu of the metric parameters, in other words, **SEtuP >> ConFiG** and press ENTER
- 4) Select the scale to be configured with the ▼ ▲ keys (only if **nuM.SCA > 1**) and press **ENTER**.
- 5) Set the zone of use: enter in the **GrAV** step and set the gravity acceleration value of the ZONE OF USE.
- 6) Press various times the C key until the instrument asks to save and confirm with **ENTER**.
- 7) The weight error caused by a different gravity attraction value between the zone of calibration and the zone of use is automatically corrected.
- 8) With various scales, one should repeat the operations from point 1).

4.4 QUICK CALIBRATION OF ZERO

Useful for calibrating only the ZERO point when a permanent tare weight is put on a platform (for example a roller unit).

- 1) Enter in the instrument set-up;
(upon start-up, press for an instant the **TARE** key while the instrument version is displayed)
- 2) Enter in the configuration menu of the metric parameters, in other words, **SEtuP >> ConFiG** and press **ENTER**
- 3) Select the scale to be configured with the ▼ ▲ keys (only if **nuM.SCA > 1**) and press **ENTER**.
- 4) Select the **0.CALib** step and press **ENTER**; the “scale unloading and press enter” message appears
- 5) Once the calibration has taken place, “ZERO CALIBRATION EXECUTED” message will appear on the display, press ENTER and the scale returns to the **PArAM** step. If one needs to calibrate other scales, press the C key, select the next scale to be calibrated and repeat all the operations from point 2.
If, on the other hand, the calibration is done, press various times the C key until the instrument asks to save and confirm with ENTER.

4.5 PEAKS FILTER

It may occur that the material falling onto the load receiver causes peak values, in such a manner that for a few fractions of a second the shown weight is incorrect. To avoid the occurrence of undesirable situations created by the difference between real weight and detected weight such as the activation of a batching output, the indicator is able to eliminate the peak values by averaging the detected weights on the basis of the BATCHING-PEAK ELIMINATION TIME (**PK.F.TIM** step) and the MAXIMUM WEIGHT VARIATION IN TIME (**PK.F.DIV** step): if the detected weights average exceeds the MAXIMUM WEIGHT VARIATION (**PK.F.DIV** step), during the dosages in loading, the weight is frozen at the window start value until the variation returns within the limits

5. DISPLAY OF THE GEOGRAPHICAL UTILISATION AND CORRECTION ZONE OF THE WEIGHING ERROR DUE TO THE DIFFERENT GRAVITATIONAL ATTRACTION BETWEEN THE CALIBRATION AND UTILISATION ZONE.

5.1 INDICATION AND/OR DISPLAY OF THE GEOGRAPHICAL UTILISATION ZONE (Compulsory for the legal type instruments)

This instrument conforms to the laws currently in force regarding non-automatic weighing instruments. Such g-sensitive instruments are influenced by the gravitational acceleration value “g” of the utilisation zone hence it is compulsory to indicate, with a label or on the display, the coded name of the utilisation zone where the weighing machine can be used. The approved instrument displays, upon start-up, the “g” value relative to the gravitational zone of use for a few seconds, after the name and the installed software version.

5.2 CORRECTION OF THE WEIGHING ERROR INTRODUCED BY A DIFFERENT GRAVITATIONAL ATTRACTION VALUE BETWEEN THE CALIBRATION AND UTILISATION ZONE

(compulsory for legal type instruments)

This instrument conforms to the laws currently in force regarding non-automatic weighing instruments. Such g-sensitive instruments are influenced by the gravitational acceleration value "g" of the utilisation zone so a special programme has been created to compensate for any differences in the gravitational attraction between the place where the weighing machine is calibrated and the place of utilisation.

During configuration the "g" values relative to the utilisation zone and to the zone of calibration are entered at a certain programming step which eliminates the weight error introduced by the different gravitational attraction value.

The approved instrument displays, upon start-up, the "g" value relative to the gravitational zone of use for a few seconds, after the name and the installed software version.

6. FUNCTION OF THE OPTOISOLATED INPUTS

INPUT	FUNCTION	DESCRIPTION
IN 1	DOSAGE START	Starting the dosage / exiting the error and pause condition.
IN 2	RESET/PAUSE	- When present, it causes the dosage to pause. - When it is present for at least 2/3 seconds it interrupts and cancels the dosage under way and it waits for the start impulse for the following dosage.
IN 3...IN 6	FORMULA SELECTION	If the function (<<FOR.SEL>> step), is enabled, it selects the formula
IN 7	STOP TIMER	If the parameter of timer activity is set on "STOPPABLE" and STOP.T→T.INPUT step is set on "INPUT7" (TECH.MAN.REF.), close the input to stop timer activity immediately.
IN 8	CANCEL PAUSE	If P.INPUT step is set on "INPUT 8", when dosage is in pause activity, close the input to resume dosage.

7. FUNCTION OF THE OUTPUTS (DEFAULT)

The following configuration is obtained carrying out the instrument default, **SEtuP >> dFLt.t** parameter.

Otherwise it's possible to programme a different functioning for the first 4 outputs. For this refer to the description of the **SEtuP >> outPutS** step

RELAY	FUNCTION	DESCRIPTION
OUT 1	DOSAGE CYCLE END	Indicates that the dosage under way is done ("formula end" output).
OUT 2	FAST SPEED	Activated at the maximum dosage speed (approximate dosage).
OUT 3	ERROR	Activated when dosage is in error condition: FORMULA MISSING BEYOND MAX TARE BELOW MIN. TARE OUT OF ZERO ERR. OUT OF ZERO INSTABILITY ERR ERR. OUT OF TIME TOL. ERR DOS+GROS > CAPAC
OUT 4	OVER TARGET	Activate it when the weight exceeds the set target.
OUT 5...OUT 16	PRODUCT OUTPUTS	Depending on the number of usable outputs, programmed in the <<MAX.out>> step, it is possible to: a) link each of these 12 outputs directly to each single dosage activity. For example, if one selects the "activity output" number 1 during the activity insertion, then output OUT5 will be used. At the same way, if one selects the "activity output" number 12 during the activity insertion, the output OUT16 will be used. (See table in AUTOMATIC DOSAGE. USER MAN.REF.) b) link 127 combinations of these outputs to each single dosage activity, in other words, the instrument outputs supply a binary code, which decoded (for example by a PLC) will select the desired relay: OUT5: DATA OUTPUT 1 OUT6: DATA OUTPUT 2 OUT7: DATA OUTPUT 3 OUT8: DATA OUTPUT 4 OUT9: DATA OUTPUT 5 OUT10: DATA OUTPUT 6 OUT11: DATA OUTPUT 7 OUT12-OUT15: NOT USED OUT16: ALWAYS ACTIVATED WITH ACTIVITY IN EXECUTION. See following section for further details.

7.1 DIAGRAM FOR DECODING THE OUTPUTS

One can expand the outputs linkable to the activities, from 12 to 127.

In the <<MAX.out>> step one should enter the number of connected outputs (to select the decoding functioning mode, one should enter a number greater than 12).

See the connection scheme in section 11.2.

ACTIVITY OUTPUT	OUT 5...OUT 16 OF THE INDICATOR								ACTIVITY OUTPUT	OUT 5...OUT 16 OF THE INDICATOR							
	16	11	10	9	8	7	6	5		16	11	10	9	8	7	6	5
1	1	0	0	0	0	0	0	0	65	1	1	0	0	0	0	0	0
2	1	0	0	0	0	0	0	0	66	1	1	0	0	0	0	0	1
3	1	0	0	0	0	0	0	1	67	1	1	0	0	0	0	1	0
4	1	0	0	0	0	0	0	1	68	1	1	0	0	0	0	1	1
5	1	0	0	0	0	0	1	0	69	1	1	0	0	0	0	1	0
6	1	0	0	0	0	0	1	0	70	1	1	0	0	0	0	1	0
7	1	0	0	0	0	0	1	1	71	1	1	0	0	0	0	1	0
8	1	0	0	0	0	0	1	1	72	1	1	0	0	0	0	1	1
9	1	0	0	0	1	0	0	0	73	1	1	0	0	1	0	0	0
10	1	0	0	0	1	0	0	1	74	1	1	0	0	1	0	0	1
11	1	0	0	0	1	0	1	0	75	1	1	0	0	1	0	1	0
12	1	0	0	0	1	0	1	1	76	1	1	0	0	1	0	1	1
13	1	0	0	0	1	1	0	0	77	1	1	0	0	1	1	0	0
14	1	0	0	0	1	1	0	1	78	1	1	0	0	1	1	0	1
15	1	0	0	0	1	1	1	0	79	1	1	0	0	1	1	1	0
16	1	0	0	0	1	1	1	1	80	1	1	0	0	1	1	1	1
17	1	0	0	1	0	0	0	0	81	1	1	0	1	0	0	0	0
18	1	0	0	1	0	0	0	1	82	1	1	0	1	0	0	0	1
19	1	0	0	1	0	0	1	0	83	1	1	0	1	0	0	1	0
20	1	0	0	1	0	0	1	1	84	1	1	0	1	0	0	1	1
21	1	0	0	1	0	1	0	0	85	1	1	0	1	0	1	0	0
22	1	0	0	1	0	1	0	1	86	1	1	0	1	0	1	0	1
23	1	0	0	1	0	1	1	0	87	1	1	0	1	0	1	1	0
24	1	0	0	1	0	1	1	1	88	1	1	0	1	0	1	1	1
25	1	0	0	1	1	0	0	0	89	1	1	0	1	1	0	0	0
26	1	0	0	1	1	0	0	1	90	1	1	0	1	1	0	0	1
27	1	0	0	1	1	0	1	0	91	1	1	0	1	1	0	1	0
28	1	0	0	1	1	0	1	1	92	1	1	0	1	1	0	1	1
29	1	0	0	1	1	1	0	0	93	1	1	0	1	1	1	0	0
30	1	0	0	1	1	1	0	1	94	1	1	0	1	1	1	0	1
31	1	0	0	1	1	1	1	0	95	1	1	0	1	1	1	1	0
32	1	0	0	1	1	1	1	1	96	1	1	0	1	1	1	1	1
33	1	0	1	0	0	0	0	0	97	1	1	1	0	0	0	0	0
34	1	0	1	0	0	0	0	1	98	1	1	1	0	0	0	0	1
35	1	0	1	0	0	0	1	0	99	1	1	1	0	0	0	1	0
36	1	0	1	0	0	0	1	1	100	1	1	1	0	0	0	1	1
37	1	0	1	0	0	1	0	0	101	1	1	1	0	0	1	0	0
38	1	0	1	0	0	1	0	1	102	1	1	1	0	0	1	0	1
39	1	0	1	0	0	1	1	0	103	1	1	1	0	0	1	1	0
40	1	0	1	0	0	1	1	1	104	1	1	1	0	0	1	1	1
41	1	0	1	0	1	0	0	0	105	1	1	1	0	1	0	0	0
42	1	0	1	0	1	0	0	1	106	1	1	1	0	1	0	0	1
43	1	0	1	0	1	0	1	0	107	1	1	1	0	1	0	1	0
44	1	0	1	0	1	0	1	1	108	1	1	1	0	1	0	1	1
45	1	0	1	0	1	1	0	0	109	1	1	1	0	1	1	0	0
46	1	0	1	0	1	1	0	1	110	1	1	1	0	1	1	0	1
47	1	0	1	0	1	1	1	0	111	1	1	1	0	1	1	1	0
48	1	0	1	0	1	1	1	1	112	1	1	1	0	1	1	1	1
49	1	0	1	1	0	0	0	0	113	1	1	1	1	0	0	0	0
50	1	0	1	1	0	0	0	1	114	1	1	1	1	0	0	0	1
51	1	0	1	1	0	0	1	0	115	1	1	1	1	0	0	1	0
52	1	0	1	1	0	0	1	1	116	1	1	1	1	0	0	1	1
53	1	0	1	1	0	1	0	0	117	1	1	1	1	0	1	0	0
54	1	0	1	1	0	1	0	1	118	1	1	1	1	0	1	0	1
55	1	0	1	1	0	1	1	0	119	1	1	1	1	0	1	1	0
56	1	0	1	1	0	1	1	1	120	1	1	1	1	0	1	1	1
57	1	0	1	1	1	0	0	0	121	1	1	1	1	1	0	0	0
58	1	0	1	1	1	0	0	1	122	1	1	1	1	1	0	0	1
59	1	0	1	1	1	0	1	0	123	1	1	1	1	1	0	1	0
60	1	0	1	1	1	0	1	1	124	1	1	1	1	1	0	1	1
61	1	0	1	1	1	1	0	0	125	1	1	1	1	1	1	0	0
62	1	0	1	1	1	1	0	1	126	1	1	1	1	1	1	0	1
63	1	0	1	1	1	1	1	0	127	1	1	1	1	1	1	1	0
64	1	0	1	1	1	1	1	1									

7.2 INTERMITTENT ACTIVATION OF THE PRODUCT OUTPUT (JOGGING FUNCTION)

If the number of outputs set in the <<MAX.out>> step is lower or equal 12, it is possible to enable the jogging function: during the loading dosages, when the target weight minus the slow weight and the flight weight is reached, the product output is activated intermittently, with the ON/OFF time programmed in the <<D.CY.ON> and <<D.CY.OFF>> steps.

8. SERIAL OUTPUTS

The indicator is fitted with two bi-directional serial ports, both having the output in ASCII code compatible with a wide range of printers, remote displays, PCs and other devices; in the set-up it is possible to freely combine these ports to the available configurations ("ComPC", "ComPrn", and "ComAux").

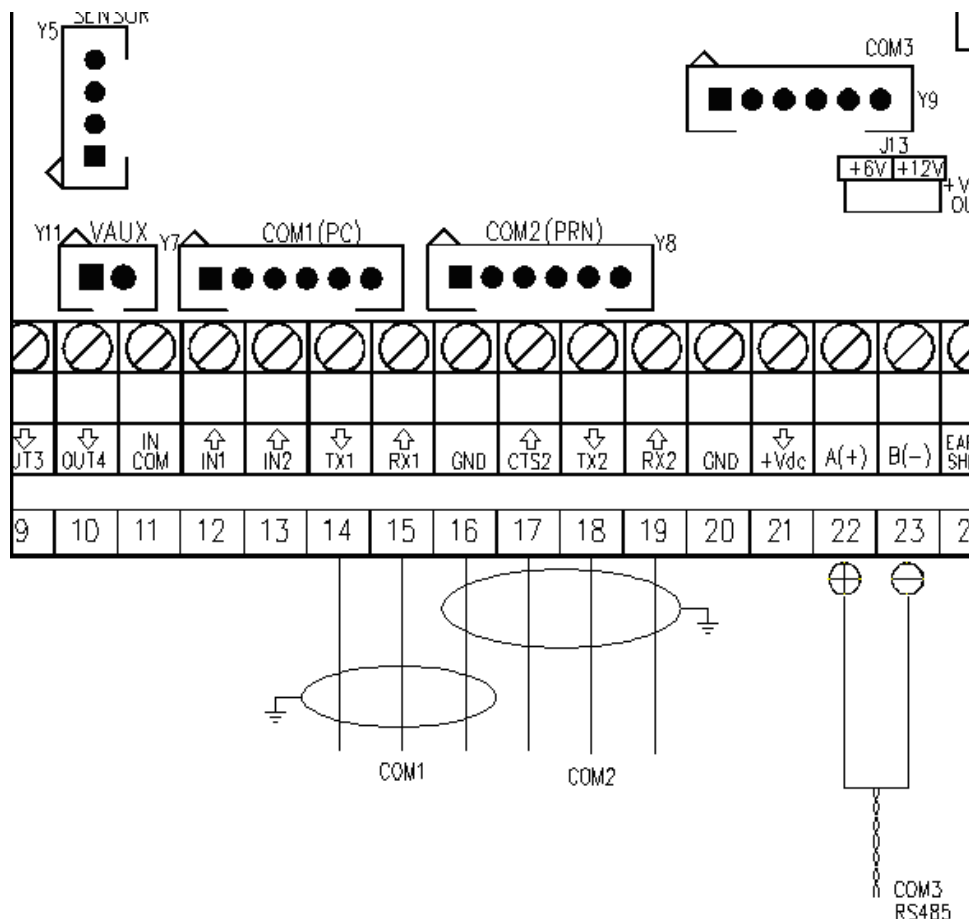

Signal	AMP Connector		Terminal board		
	COM1/COM3 (RS232)	COM2 (RS232)	COM1 (RS232)	COM2 (RS232)	COM3 (RS485)
TX	1	1	14	18	22 A(+)
RX	2	2	15	19	23 B(-)
GND	6	6	16	16	-
CTS	2	3	15	17	-

By the step **SEtUp >> SERIAL >> PortS** it is possible select the function of the serial ports:

Parameter	COM 1	COM 2	COM 3
PC.Pr.AX (!)	ComPC	ComPrn	ComAux
PC.AX.Pr	ComPC	ComAux	ComPrn
Pr.PC.AX	ComPrn	ComPC	ComAux
Pr.AX.PC	ComPrn	ComAux	ComPC
AX.PC.Pr	ComAux	ComPC	ComPrn
AX.Pr.PC	ComAux	ComPrn	ComPC

ComPC: data transmission/reception to PC/PLC, printer, repeater.

ComPrn: data transmission to printer, repeater

ComAux: data transmission/reception to printer, repeater, reception remote scale, barcode reader.

!! IMPORTANT !!

THE CONNECTION AND THE SOFTWARE CONFIGURATION OF THE SERIAL PORTS MUST BE MADE BY TECHNICAL PERSONNEL WHO KNOWS THE PROCEDURES ON THE BASIS OF THE USER'S NEEDS.

The data transmission cable must be kept away from the AC power supply lines.

!! REMOVE VOLTAGE BEFORE OPENING THE INSTRUMENT !!

THE STANDARD CONFIGURATION OF THE SERIAL PORTS IS THE FOLLOWING:

Baud rate = 9600, Parity = None, Data word = 8, Stop bit = 1, CTS signal = No Cts. The configuration may be modified in the SET-UP environment in the << **SERIAL** >> step.

8.1 RS 485 CONNECTION

Below is the RS485 connection of the indicator in the CoM3:

Meaning	Indicator Serial line
TX-/RX-	22 A(+)
TX+/RX+	23 B(-)

On the same RS 485 line it's possible to connect up to 32 devices, among indicators, digital load cells, 485/232 signal converter.

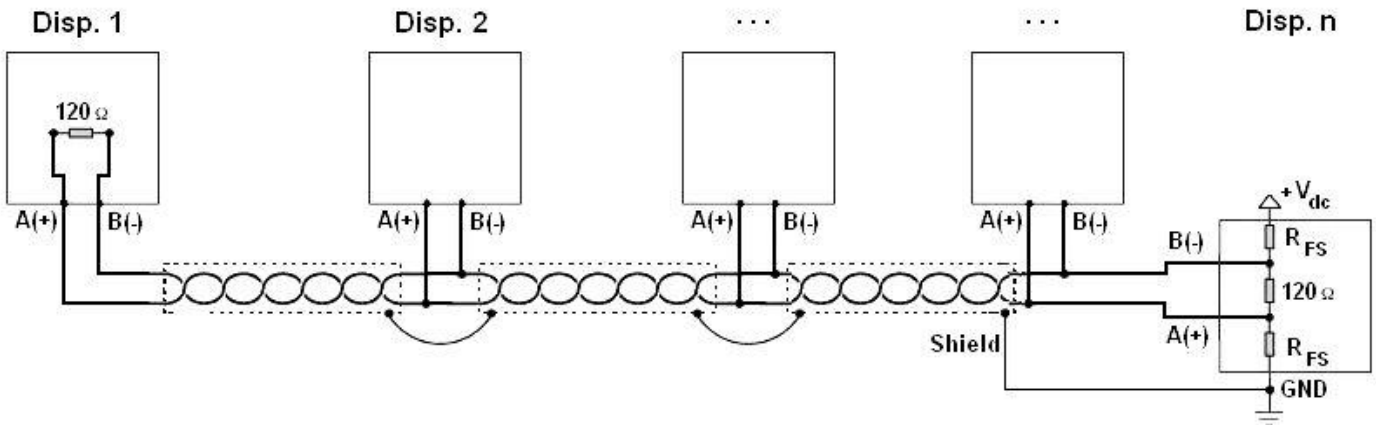

Figure 1: electrical diagram of RS485 connections.

- Use a **STP** (Shielded Twisted Pair) cable in order to make the connection (twisted and shielded pair/s with single shielding for each pair through aluminium band and total shielding through external sheathing).
- The maximum reachable length from the line with the use of the appropriate cable for RS 485 connections, the twisted 2x24 AWG duplex cable, shielded with external sheathing + aluminium band, is of about 1200 meters (see section 1.1.3)
- With very long cables, the cable capacity (normally near 50pF/m) starts being a dominant factor in the power consumption and increases with the increase of speed.

This implies that **the maximum distance can not be covered with the maximum possible speed**. For an approximate value, one can consult the following table:

Baud rate	Total capacity of the cable (pF)
1200	400000
2400	200000
4800	100000
9600	50000
19200	25000
38400	12000
57600	8000
115200	4000

As a general rule, if one has any doubts, it is always preferable to **choose the cable with a greater section.**

- Verify that the grounding satisfies the requirements of section 1.2. Especially, all the digital masses, as well as the analogue masses, and the power circuits, must be connected to the grounding bar and this last one must be connected to the grounding pole.
- The shielding can be connected into a single point of the entire network (as shown in Figure 1) or both its ends, however it's important that **all the masses have the same potential**, in order to avoid the forming of current rings.
- On the RS485 network normally one connects 2 **termination resistances** equal to the characteristic impedance of the cable (typically 120 Ω, see Figure 1), **ONLY** on the 2 devices **which are at the 2 ends of the cable**. The terminal resistance is not supplied with the ports of the indicator.
- The difference of potential between the A(+) and B(-) terminals in rest conditions (for example with instrument in set-up phase), **must be of at least 0,2 V**.
To create a resistive divider which maintains this difference of potential also when all the transmitters are disabled, inert in the RS485 port of the indicator where there are the termination resistances, the **polarisation or fail-safe resistances** (R_{FS} in Figure 1). The value of these resistances is between 390 Ω and 2,2 kΩ.

NOTE: in particular, the value of each of these resistances must be greater than the value calculable through the formula:

$$R_{FS} = \frac{R_{eq}}{2} \times \left(\frac{V_{dc}}{0,2} - 1 \right)$$

in which:

- V_{dc} is the power supply voltage of the line
- R_{eq} is the overall resistance to the A(+) a B(-) heads, supplied by the parallel of the 2 termination resistances and all the input resistances of the devices connected to the bus.

FOR EXAMPLE:

Presuming that a connection has 120 Ω as termination resistance and 32 connected devices, each having an input impedance of 12 kΩ. The V_{dc} power supply is 5 V.

One calculates R_{eq} , equal to about 52 Ω, and R_{FS} which must be at least equal to 624 Ω.

- **The connection between the indicator and the digital load cells is made with RS485 protocol in the COM3 configured as CoMAuX.** The indicator can be connected with up to 16 digital load cells.
- It's possible to connect the indicator to digital load cells with 485 4-wire protocol through 422/232 converter. In this case one is required to connect the double TX of RS422 cable to TX+ and TX- converter's pins and the double RX of RS422 cable to RX+ and RX- converter's pins
- In case of connection with non Dini Argeo devices, there may be different ways of line marking: generally one presumes that the A/B indication corresponds to the +/- and HI/LO markings, but this is not always true. Therefore, if the device does not function, one should try inverting the connections even if everything seems to be correct.
- For the correct functioning of the digital load cells, one should, in any case respect all the rules given in the relative specific manuals.

8.2 PC CONNECTION

9 PIN CONNECTOR

INDICATOR	9 pin Collector	Color
TX	3	Yellow
RX	2	Pink
GND	5	Grey

8.3 PRINTER CONNECTION

	WTY280 /SMT80 9pin (female)	TMU295 /LX300 25pin (female)	LP542 Plus /TTP243/SMTPLUS 9pin (female)	Standard cable
TX	3	3	3	Brown
CTS	4	20	8	Pink
GND	7	7	5	Grey

TPR	STANDARD CABLE
GND	Black
CTS	Yellow
RX	Grey

TPR printer power supply		
	STANDARD CABLE	Terminal box
+VP e +VC	Red and Orange	5 Vaux
GND e GND	Black and Black	16 GND

8.4 TRANSMISSION PROTOCOLS

STANDARD

[available for ComPc, ComPm, ComAux]

The weight data transmission on the serial port happens in the following format:

[CC]HH,KK,PPPPPPP,UM<CR LF>

in which:

[CC] = instrument code, es.00 (only with RS485 protocol)

HH = UL Underload
OL Overload
ST Weight stability
US Weight instability

, Comma character

KK = NT Net Weight
GS Gross Weight

, Comma character

PPPPPPP = Weight (8 digits including the possible sign and decimal point)

, Comma character

UM = Unit of measure (Kg, g, t, lb)

<CR LF> Carriage Return + Line Feed (ASCII Characters 13 and 10)

AF0X

[available for ComPc, ComPrn]

The weight data transmission on the serial port happens in the following format:

[CC]SS,B,LLLLLLLLLLUM,YYTTTTTUM<CR LF>

in which: **[CC]** = instrument code, es.00 (only with RS485 protocol)

SS UL Underload
 OL Overload
 ST Weight stability
 US Weight instability

, Comma character

B Scale Number

, Comma character

LLLLLLLLLL Gross weight (10 digits including the possible sign and decimal point).

UM = Unit of measure (Kg, g, t, lb)

, Comma character

YY - 2 spaces if the tare is automatic, or
 - PT if a tare is pre-set or set manually

TTTTTTTTTT Tare weight (10 digits including the possible sign and decimal point).

UM = Unit of measure (Kg, g, t, lb)

<CR LF> Carriage Return + Line Feed (ASCII 13 and 10)

Note: this protocol doesn't work while running a formula, but only when waiting for start and pause.

DINI ARGEO REPEATER

[available for ComPc, ComPrn, ComAux]

Transmission protocol for connection to a Dini Argeo weight repeater. It transmits the weight value shown on the display to the Dini Argeo weight display.

In this case, the setting of the << **PC.Mode** >> "TRANSMISSION TYPE" parameter has no relevance.

MONODIRECTIONAL

[available for ComPc]

Through this communication protocol the serial command management is excluded, in order to avoid possible responses to data received from the port in case of use of the 485 serial line; it can be useful when one uses the port for transmitting a printout, and various devices are connected on the same 485 line. With this protocol the data and serial command reception is disabled.

COMPOSITE REPEATER

Premise: Transmission protocol for connection to a Dini Argeo (DGT series) weight repeater.

Through this communication protocol, it's possible to choose which fields (up to 5) make up the information transmitted on the serial port.

Once this protocol is selected, one is asked through the "Fld.0X" (X=1,2,3,4,5) message to scroll the selectable steps and to choose which field to transmit. The configuration automatically ends after having chosen the fifth field or with the selection of the "End" field.

This information can be viewed on a correctly configured repeater instrument which has the corresponding 0X (X=1,2,3,4,5) address.

The selectable fields are the following:

For.idX Formula index in the "xxxxxx" format aligned to the right and non significant digits filled with spaces.
 "no.ForM" if no formula is selected.

For.dES Formula description in the "xxxxxx" format aligned to the left and non significant digits filled with spaces. If the description is longer than 6 characters, the excess letters are not displayed.

Act.idX	"no.ForM" if no formula is selected. Activity index in the "xxxxxx" format aligned on the right and non significant digits filled with spaces.
Act.dES	"no.ForM" if no formula is selected No data out of the dosage cycle. Activity description in the "xxxxxx" format aligned on the left and non significant digits filled with spaces. If the description is longer than 6 characters, the letters in excess will not be displayed.
tArGEt	"no.ForM" if no formula is selected. No data out of the dosage cycle. Target weight for the activities of automatic and manual dosage, manual weight, and partial unloading in the "xxxxxx" format aligned on the right and non significant digits filled with spaces. "tot.unL" for the total discharge; "tiMEr.A" for the timer. "PAuSE.A" for the pause.
rEM.WEi	"no.ForM" if no formula is selected. No data out of the dosage cycle. Weight missing from the target and at the end of the activities in the "xxxxxx" format aligned to the right and non significant digits filled with spaces. "tiMEr.A" for the timer. "PAuSE.A" for the pause.
Act.tyP	"no.ForM" if no formula is selected. No data out of the dosage cycle. Activity tipe aligned on the the left. Displays one of the following: "Aut.btC" for the automatic dosage "MAn.btC" for the manual dosage "tiMEr" for the timer "PAuSE" for the pause "MAn.Wgt" for the manual weight "unLoAd" for the total, partial, and fractioned discharge activities
CyCLES	"no.ForM" if no formula is selected Dosage cycle number in the "xxx/yy" format in which: xxx: cycle aligned to the left yy: cycle total aligned to the right the filling character is the space
WEiGht	Weight shown on the display aligned to the right and non significant digits filled with spaces
doS.StA	Status of the dosage, aligned to the left. Displays one of the following: "WAit" out of the dosage cycle "A.d.FASt" automatic dosage at approximate speed "A.d.SLoW" automatic dosage at fine speed "A.d.FLy " automatic dosage in flight "M.d.StArt" manual dosage start "M.d. oK" manual dosage within tolerance "M.d.Err " manual dosage error "M.d.FASt" manual dosage at approximate speed "M.d.out.L" manual dosage, out of lower tolerance but greater than the slow one "M.d. LoW" manual dosage within tolerance and less than target "M.d.out.h" manual dosage out of upper tolerance "M.d.high" manual dosage within tolerance and greater than target "W.UnLd " wait unloading "UnLoAd" partial unloading "tot.unL" total unloading "un.FASt" quick partial unloading

"un.SLoW"	fine partial unloading
"un. FLY"	flight partial unloading
"TiMEr "	timer activity
"PAuSE.A"	pause activity
"MAn.WGT"	manual weight activity
"PAuSE "	cycle pause
"out.ZER"	out of zero
"out.CAP"	over range
"out.tiM"	error out of dosage time
"unStAb"	unstable weight at dosage start
"out.toL."	out of tolerance

End Introduction end (to have less than 5 fields)

8.5 TRANSMISSION MODES

TRANSMISSION ON REQUEST

[available for ComPc]

It requires an external command from the PC to send the data requested. Transmission can take place at any time requested.

CONTINUOUS TRANSMISSION

[available for ComPc, ComPrn, ComAux]

- ComPC: Continuous transmission of the standard string (**ProtoC = StAnd** step) or of the extended AF0X string (**ProtoC = AF0X** step) or continuous transmission of the customised string.
This mode is used for interfacing to the computer, remote displays, and other devices which require a constant update of the data independently from the weight stability (10 transmissions per second with a Baud rate at 9600 and stable weight).
- ComPrn: The indicator transmits continuously the data configured in the 01 print format.
Alternatively, by setting only the "300" block in the 01 print format, it is possible to transmit the STANDARD STRING (or the AF0X STRING, if configured for the PC port).
For configuration details of the print formats, see section 10.
- ComAux: The weight transmission on the serial port takes place with the STANDARD protocol.

RS485 TRANSMISSION

[available for ComPc]

On Com3 is available a RS485 Half Duplex serial output, enabling the possibility of bi-directional communication up to 63 indicators to just one computer.

The transmission protocol is the same as that of transmission upon request, with the adding of a code that identifies the weight indicator (i.e. "00READ <CR LF>").

8.6 SERIAL COMMANDS FORMAT

LEGEND

[CC]= instrument code, i.e.. 00 (only with 485 protocol).

<CR LF>= Carriage Return + Line Feed (ASCII 13 and 10 characters).

SERIAL ERRORS

With each serial command received, the instrument transmits a string containing the response (see the command description) or one of the following indications:

OK<CR LF> is shown when one transmits a correct command to the indicator. The OK response does not imply that the instrument executes the command.

ERR01<CR LF> is shown when one transmits a correct command to the indicator followed however by letters entered by mistake (I.E.: READF TARES...).

ERR02<CR LF> is shown when one transmits a correct command to the indicator containing the wrong data.

ERR03<CR LF> is shown when one transmits a command not allowed by the indicator. It can be a command not used in the selected functioning mode, or the command reaches the indicator in the instant in which the keyboard buffer is already occupied by another command.

ERR04<CR LF> is shown when one transmits an inexistent command.

NOTA: The instrument does not transmit any indication to brief commands, in other words, ones made up by one single letter plus an eventual parameter.

Version reading

Instrument response : [CC]VER<CR LF>
[CC]VER,vvv, E-BATCH<CR LF>
In which: vvv is the firmware version

Data reading:

Instrument response: [CC]READ<CR LF> or: [CC]R<CR LF>
see section 8.4 COMMUNICATION PROTOCOLS

Tare: [CC]TARE<CR LF> or: [CC]T<CR LF>

Tare condition:

Instrument's answer: [CC]TAREB<CR LF>
[CC]OK<CR LF>: the tare execution can be correctly done.
[CC]KO<CR LF>: tare is not permitted (tare disabled, weight instability, weight in overload, etc)

Fixed tare:

in which: [CC]WTTTTTT<CR LF>
[CC]TMANTTTTTT<CR LF>
W, TMAN= command
TTTTTT = tare in ASCII, max 6 characters.
Example: W10.0 <CR LF>

Zero:

[CC]ZERO<CR LF> or: [CC]Z<CR LF>

Zero condition:

Instrument's answer: [CC]ZEROB<CR LF>
[CC]OK<CR LF>: the zero execution can be correctly done.
[CC]KO<CR LF>: zero is not permitted (weight instability, weight in overload, etc)

Clear:

[CC]CLEAR<CR LF> or: [CC]C<CR LF>

Net/Gross change:

[CC]NTGS<CR LF>

Print command:

[CC]PRNT<CR LF> or: [CC]P<CR LF>

Print condition:

Instrument's answer: [CC]PRNTB<CR LF>
[CC]OK<CR LF>: the print execution can be correctly done.
[CC]KO<CR LF>: print is not permitted (weight instability, print not reactivation, cts error, etc)

Reading of extended weight string: [CC]REXT<CR LF>

Instrument's answer:

[CC]B,hh,NNNNNNNNNN,YYTTTTTTTT,PPPPPPPPP,MMMMMMMMMM,uu<CR LF>

in which: [CC] = INSTRUMENT CODE IN THE FORMAT OF TWO ASCII DECIMAL DIGITS
ONLY WHEN THE 485 PROTOCOL IS SELECTED (FOR EXAMPLE 00)

hh = UL Underload
OL Overload
ST Stability of the display
US Instability of the display

B = scale number (zero for the remote scale)

NNNNNNNNNN = net weight on 10 characters including sign and decimal point

YY = "PT" if the tare weight is entered with the keyboard, otherwise YY = " " (two space characters) if the tare weight is weighed

TTTTTTTTTT = tare weight on 10 characters including sign and decimal point

PPPPPPPPP = always 0

MMMMMMMMMM = always 0
 uu = Unit of measure "Kg" "bg" "bt" "lb"
 CR = Carriage Return (ascii character decimal code 13)
 LF = Line Feed (ascii character decimal code 10)

[GR10] Reading the next weight times 10

Syntax

Format	<CC><II>GR10<CR LF>
Parameters	
Response	<CC><II>HH, KK, P P P P P P P P, UM<CR LF> HH UL Underload OL Overload ST Weight stability US Weight instability , : Comma character KK : GX Weighing times 10 status , : Comma character P P P P P P P P : Net weight with sensitivity times 10 , : Comma character UM : Kg Unit of measure
Example	01GR10<CR LF>
Result	01ST, GX, 0.1001, kg<CR LF>
Time-out max	

Scale switch:

in which:

[CC]Qn<CR LF>

Q = command

n = scale number (from 1 to 4)

Example: Q1+CR LF

Viewing temporarily message on the display:

in which:

[CC]DISPNNVVVVVV<CR LF>

NN: display number of the indicator, standard 00 (ascii hex)

V: character to be shown (at least 1, cut off at the number of characters visualised by the shown display)

The message remains for the time which set with the DINT command; if one selects to view the message permanently on a display and one wants to cancel the operation, send the DISPNN command without any message: the display, specified in the command, (NN) goes back to viewing the usual information relative to the selected functioning mode.

Setting display visualisation interval:

in which:

[CC]DINTXXNNNN<CR LF>

XX: code which identifies the display (01 for LCD)

NNNN: visualisation interval (in milliseconds), N is an ascii hex character; for example, to set a visualisation time of 2 seconds (therefore 2000 milliseconds), which converted in hex become 07D0, the command becomes DINT07D0<CR><LF>.

By setting NNNN = 0000, the transmitted message with the DISP command (see above), remains permanently shown on the selected display.

With approved instrument

- One should wait for the end of the current visualisation before being able to view the next one.

AFX string reading and scale information: [CC]RALL<CR LF>

Instrument answer:

[AFX string] B,NNNNNNNUM,LLLLLLLUM,PPPPPPN,SSS,AAA,CCC,TTT,XXXXX-YYYYYY<CR LF>.

in which:

B Number of platform on which the totalisation has been made.

NNNNNNNUM Last net weight totalized with unit of measure.

LLLLLLLUM Last gross weight totalized with unit of measure.

PPPPPP Last pieces totalized.

SSS Scale status: 000 start-up
001 weighing
002 selection of functioning mode
003 generic menu
004 set-up menu
005 user menu
006 exit from set-up
007 Update Firmware status
008 setting of user default
009 setting of technical default
010 switch channel
011 setting of technical default
012 Test of the PC serial ports
013 Test of the PRN serial ports

AAA Counter of pressed keys.

CCC Code of last key pressed.

TTT Counter of totalisations.

XXXXX Last rewriting number stored in the Alibi memory.

YYYYYY Last weigh number stored in the Alibi memory.

Create the temporary communication bridge between PC port and printer or aux port: [CC]BRIDGE<CR LF>

Instrument's answer:

[CC]OK<CR LF>:

In which: x indicates 1 for printer port, 2 for aux port.

If the communication is OK, the LED display shows "bridGE" message, while the LCD display shows "COM1 <-> COM2" if the PC port communicates with printer port, or "COM1 <-> COM3" if the PC port communicates with aux port.

8.7 ADVANCED COMMANDS

The following command allows for **the reading of the data in the keyboard buffer** (only if the transmission of the pressed keys code is disabled):

Syntax

Format	<CC><II>GKBB<CR LF>
Parameters	-
Answer	- <CC><II>OK<CR LF> if the buffer is empty - If the buffer is not empty, two hexadecimal characters for each key, in the order in which these have been pressed, from left to right.
Example	01GKBB<CR LF>
Result	If for example, with empty keyboard buffer, the 1, 2, 3, 4, 5, 6 keys have been pressed, the instrument answer will be the following: 080900B0C0D<CR LF>

NOTE: the reading of the keyboard buffer causes the cancellation.

Furthermore, only if the transmission of the pressed keys code is disabled, it is possible to **cancel the contents of the keyboard buffer** with the following command:

Syntax

Format	<CC><II>EKBB<CR LF>
Paramers	-
Answer	<CC><II>OK<CR LF>
Example	01EKBB<CR LF>
Result	Cancellation of the keyboard buffer

[INUA] Request of a numeric value entry on the LCD display:**Syntax**

Format	<CC><II>INUA<CC><LL><I><CR LF>
Parameters	CC = decimal position from which the entry of the numeric data starts, from left to right. LL = number of characters in decimals which make up the numeric data to be entered I = selection/unselection of the display of an initial value, previously entered in the user buffer (using the WUBU command described later on): - I = 0 not displayed - I = 1 displayed
Answer	<CC><II>OK<CR LF>
Example	01INUA08071<CR LF>
Result	If <u>preceded</u> by the 01WUBU1234567<CR LF> command, it causes the 1234567 message to be shown on the LCD display, with the character 1 blinking, starting from the position 08 of the LCD display (in other words the digit 8). At this point it is possible to set 8 numerical digits which will substitute the displayed ones.

NOTE: If an alphanumeric string is in the buffer, a number of blank spaces corresponding to the number of digits set in LL will be shown on the display, starting from the set cursor position.

[IALA] Request of alphanumeric text entry on the LCD display:**Syntax**

Format	<CC><II>IALA<CC><LL><I><CR LF>
Parameters	CC = decimal position from which the entry of the numeric data starts, from left to right. LL = number of characters in decimals which make up the numeric data to be entered I = selection/unselection of the display of an initial value, previously entered in the user buffer (using the WUBU command described later on): - I = 0 not displayed - I = 1 displayed
Answer	<CC><II>OK<CR LF>
Example	01IALA08071<CR LF >
Result	If <u>preceded</u> by the 01WUBUABCDEFGH<CR LF> command, it causes the ABCDEFGH message to be shown on the LCD display, with the character 1 blinking, starting from the position 08 of the LCD display (in other words the digit 8). At this point it is possible to set 8 numerical digits which will substitute the displayed ones.

NOTE : in order to enter a value on the LCD display, one should select the "oUEr" writing mode, pressing at length the SHIFT key. (**USER MAN REF.** "ENTRY OF ALPHANUMERIC TEXT" section)

When exiting the entry phase, the displayed data is frozen on the LCD display and it remains until a new serial command does not switch the visualisations (for example a DISP command or a new visualisation entered with the INUA or IALA commands, previously described).

The turning off causes the restoration of the standard weight data.

[GINR] Reading of entered data:

GINR + CR + LF

Syntax

Format	<CC><II>GINR<CR LF>
Parameters	-
Answer	- 2 if one exits from the entry phase with the C key; - 1 if the value has been entered and confirmed with ENTER To read the entered string, use the RUBU<CR LF> command described later on
Example	01GINR<CR LF>
Result	Reading of the user buffer and transmission of the data read on the PC

Reading and writing of the user buffer:

Premise: the user buffer is the memory area in which the temporary storage of entered data is used (using the indicator keyboard) by the user or made visible by the user.

The previous request commands on the display of data entry, taking advantage of this buffer.

[WUBU] Reading of the user buffer:

Syntax

Format	<CC><II>WUBU<AAA...A><CR LF>
Parameters	AAA...A is the numeric and/or alphanumeric string (UP TO 32 characters) which are entered in the user buffer
Answer	<CC><II>OK<CR LF>
Example	01WUBU<ABCDE><CR LF>
Result	The ABCDE string is stored in the user buffer

IMPORTANT: do not modify the user buffer while the instrument is waiting for the data entry: this operation can cause system malfunctioning, which are eliminated only when the instrument is turned off.

[RUBU] Reading of the user buffer:

Syntax

Format	<CC><II>RUBU<CR LF>
Parameters	-
Answer	<CC><II>AAA...A <CR LF> In which AAA...A is the numeric and/or alphanumeric string (UP TO 32 Characters), read in the user buffer. If the number of characters is less than 32, blank spaces will be added in order to complete the 32 transmitted characters.
Example	01RUBU<CR LF>
Result	01STRING <CR LF>

[TOPR] Transmission of numeric and/or alphanumeric string to printer:**Syntax**

Format	<CC><II>TOPR<XXX...X> <CR LF>
Parameters	XXX...X = numeric and/or alphanumeric string which one wants to print
Answer	<CC><II>OK<CR LF> The answer does not imply that the command has been made.
Example	01TOPRABCDE<CR LF>
Result	The ABCDE string will be printed

TECHNICAL NOTE: The reception and transmission buffers of the indicator are of 256 bytes; knowing that each transmitted character is equal to one byte, the maximum number of characters which can be transmitted is 248. This value changes depending on the transmitted data.

NOTES:

- It is possible to print numeric and alphanumeric characters (A...Z, a...z, 0...9), for example TOPRABCabc123 + CR + LF.
- It is possible to print ascii characters by entering the corresponding decimal code (on three digits) preceded by the \ character; for example, if one wants to print the message <!!ATTENTION!!>, the command will be the following: TOPR\060\033\033ATTENTION\033\033\062+ CR + LF;
- It is possible to print the print blocks by entering the block number preceded by the \M abbreviation; for example, if one wants to print the block 301 NET WEIGHT, 302 GROSS WEIGHT, 303 TARE, the command will be the following:
TOPR\M301\M302\M303 + CR + LF
- The command is not enabled if the instrument is approved.

[OIN] Key with which one has exit from the user input

With this command it is possible to know which key the user used to exit the input (ENTER or C).

Syntax

Format	<CC><II>OIN<CR LF>
Parameters	-
Answer	<CC><II>OIN[<KEY> NO]<CR LF>
Key	ENT Exited with the Enter key CLR Exited with the Clear key
Example	01OIN<CR LF>
Result	01OINENT<CR LF>

If the command is wrong one will have the <ESC><II>OINNO<STX> message.

Key pressure simulation command**[CC]KEYPXX<CR LF>**

in which XX is the code of the pressed key:

CODE	PRESSED KEY
00	F1 key
01	F2 key
02	F3 key
03	F4 key
04	F5 key
05	F6 key
06	F7 key
07	F8 key
08	F9 key
09	F10 key
0A	'0' numeric key
0B	'1' numeric key
0C	'2' numeric key
0D	'3' numeric key
0E	'4' numeric key
0F	'5' numeric key
10	'6' numeric key
11	'7' numeric key
12	'8' numeric key
13	'9' numeric key
14	(.) point key
15	ZERO key
16	ENTER/Fn key
17	2ndF key
18	C key

Instrument response: OK<CR LF>: accepted command.

In case the simulated key has two linked functions (key briefly pressed or at length, like the TARE key), if the KEYP command is followed by the release command of the (KEYR) key within a maximum time of 1,5 seconds, the simple function will be executed (key briefly pressed); otherwise the second function will be made (key pressed at length).

Key release simulation command**[CC]KEYR<CR LF>**

Response: [CC]OK<CR LF>

Serial command which supplies the indicator status**[CC]STAT<CR LF>**

Instrument answer: [CC]STATXX<CR LF>

in which XX is a decimal value which supplies the status of the indicator; the possible values are:

XX indicator status

- 00 normal scale status
- 01 normal scale status in input
- 02 instrument in technical setup
- 04 instrument in boot phase
- 05 instrument in rx/tx setup phase
- 06 instrument in test phase of the serial ports
- 07 instrument in print test
- 08 instrument in firmware update phase
- 09 instrument in stand-by
- 10 instrument in automatic zero phase
- 12 instrument in inputs test phase

Serial command which supplies the indicator status and the dosage status

Reading Total Weight (only in Total Weight mode) The command is allowed in the state of wait for start.

[CC]DWEI<CR LF>

Instrument answer: [CC]LLLLLLLLLLUM<CR LF>:

In which LLLLLLLLLL is the weight of 10 decimal digits
UM is the unit of measurement stored in the archives

The command can read the total weight set in <<WGT.FOR>>

Setting Total Weight (only in Total Weight mode) The command is allowed in the state of wait for start.

[CC]DWEI,XXX<CR LF>

Instrument answer: [CC]OK<CR LF>: accepted command.

In which XXX is the total weight for the formula to be set.

The command allows to set the total weight one want to dosing and indicator recalculates the weights of all the activities to be determined.

[CC]STATB<CR LF>

Instrument answer: [CC]STATXX-BYY<CR LF>

in which XX is a decimal value which supplies the status of the indicator (see the STAT command);
YY is a decimal value which supplies the dosage status; some values are:

YY dosage status

- 00 No selected formula
- 01 Local database management
- 02 Remote database management
- 03 Remote command management
- 04 Cycle start wait with Out of Capacity Formula
- 05 Cycle start wait with missing material
- 06 Cycle start wait in Weight Error
- 07 Reserved
- 08 Cycle start wait in First Weigh Error
- 09 Cycle start wait
- 10 Activity selection
- 11 Automatic dosage activity at maximum speed
- 12 Automatic dosage activity at minimum speed
- 13 Reserved
- 14 Automatic dosage activity: wait for flight time
- 15 Manual Dosage Start Test Start
- 16 Manual dosage activity (tot.WGt mode) able to start
- 17 Manual dosage activity (tot.WGt mode) not able to start due to incorrect target value
- 18 Manual dosage activity at maximum speed
- 19 Manual dosage activity NOT OK because under the lower tolerance
- 20 Manual dosage activity OK which is between the lower tolerance and the target
- 21 Manual dosage activity NOT OK because over the upper tolerance
- 22 Manual dosage activity OK which is between the upper tolerance and the target
- 23 Wait for discharge activity start
- 24 Discharge Start Test
- 25 Total discharge activity
- 26 Discharge activity at maximum speed
- 27 Discharge activity at minimum speed
- 28 Discharge activity: wait for flight time
- 29 Timer activity
- 30 Pause activity

- 31 Manual weight activity
- 32 Cycle Pause
- 33 Error: Out of zero
- 34 Error: Out of scale capacity
- 35 Error: Out of foreseen maximum time
- 36 Error: Out of foreseen triggering time
- 37 Error: Unstable weight
- 38 Error: Out of tolerance
- 39 Reserved for remote dosage
- 40 Reserved for remote dosage
- 41 Reserved for remote dosage
- 42 Alarm for Timer activity
- 43 Saves weight data
- 44 Activity end
- 45 Wait for the remote reading
- 46 Remote dosage
- 47 Synchronization for remote dosage
- 48 End of cycle
- 49 Reset of the cycle

Serial command which supplies the complete dosage status

[CC]BSTAT<CR LF>

Instrument answer: [CC] B,S,F,P,C,R,O,AO,NP,W,TD,D,FT<CR LF>

in which:

B: scale (adc channel, from 1 to 4)

S: dosage status (see STATB command)

F: index of formula in execution

P: index of activity in execution

C: cycle number

R: number of foreseen repetitions

O: output status. It's a value which in the binary code indicates from right to left (R1 last on the right, R11 first on the left) the status of the outputs (1=enabled output, 0=disabled output).

For example 1026 (1000000010 in binary) indicates that both R2 and R11 are active.

AO: Analogue output value

NP: number of the activities of the active formula

W: present gross weight

TD: weight to dose in the active activity (time if timer activity)

D: dosed weight in the active activity

FT: active formula total dosed

Selection formula

[CC]DSETxx<CR LF> in which XX is the selecting formula index.

Instrument answer: [CC]SETOK<CR LF>: accepted command.

[CC]ERROR<CR LF>: not present formula or already selected.

Dosage start

[CC]DSTART<CR LF>

Instrument answer: [CC]START<CR LF>: accepted command.

[CC]ERROR<CR LF>: otherwise.

Dosage PAUSE/RESET

[CC]DSTOP<CR LF>

Instrument answer: [CC]PAUSE<CR LF>: dosage pause – if the command is received with the dosage under way.

[CC]RESET<CR LF>: cancelling of dosage under way – if the command has been received during the pause status.

[CC]ERROR<CR LF>: if the command has been received out of the dosage status.

9. ANALOGUE OUTPUT (OPTIONAL)

Through an optional interface, it is possible to use a 16-bit analogue output configurable at 0 – 10V, 0 – 20 mA or 4 – 20 mA. Settable in different mode for each scale.

The voltage and the output current from the interface are proportional to the dosed gross or net weight or to the dosage speed, depending on how the <<ModE>> step has been programmed.

- ANALOGUE OUTPUT ON THE NET OR THE GROSS**

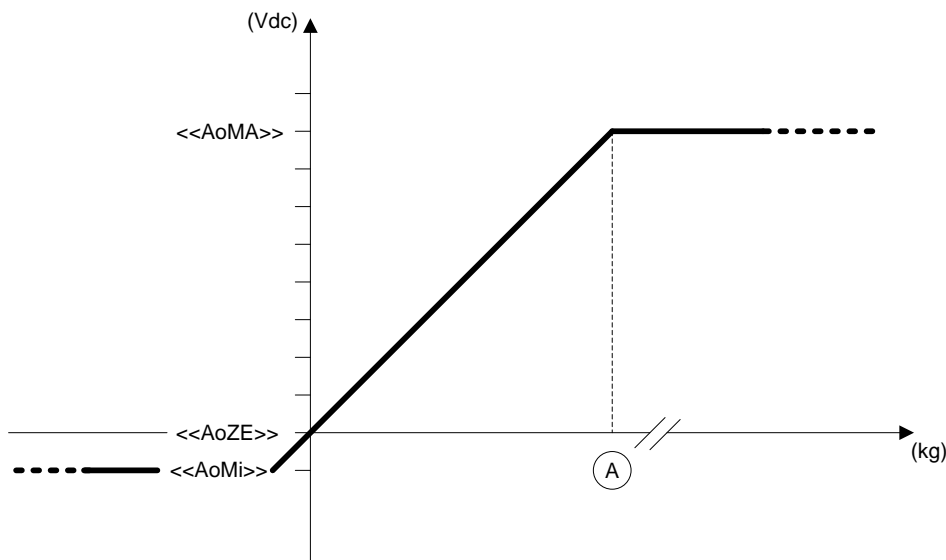

Example of the analogue output trend for a dosage in loading

- ANALOGUT OUTPUT ON THE SPEED (AUTOMATIC DOSAGE EXAMPLE)**

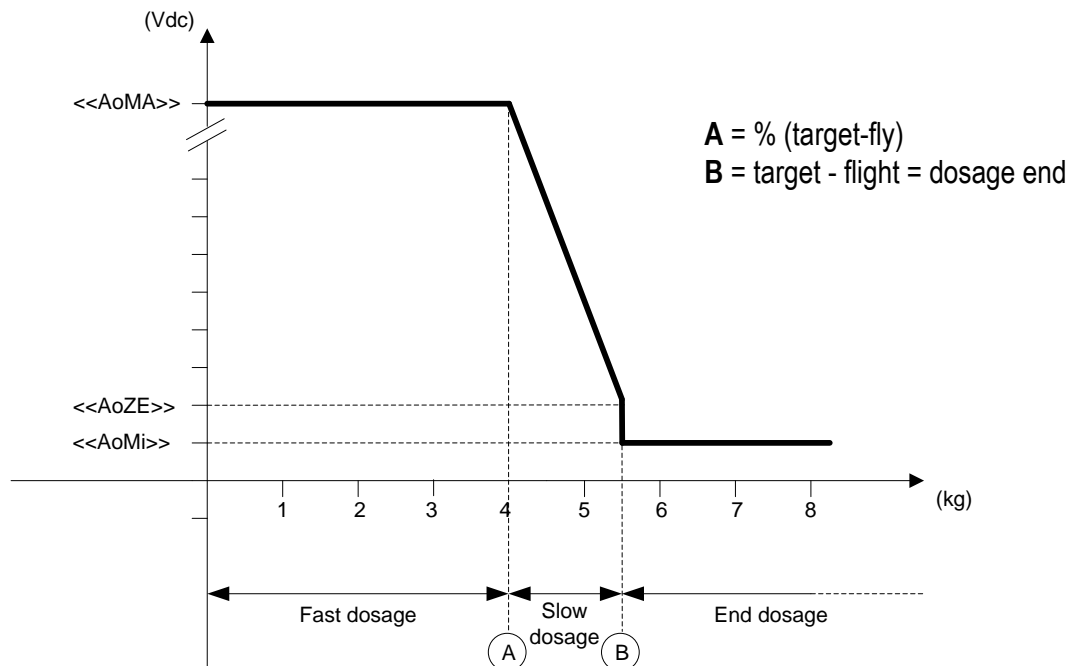

Example of the analogue output trend for a dosage in loading

NOTA:

- If the analogue output is proportional to the speed, for the TIMER, PAUSE and MANUAL WEIGHT activities, the output remains fixed to the minimum value, while for the total unloading activity, remains fixed to the maximum value.
- Out of the dosage cycle, the analogue output is always proportional to the gross weight on the scale.

In regards to the connections, see the electric scheme in section 11.

In order to configure the parameters, one needs to enter the <<Anout>> step.

In this order, one should configure the following parameters:

<<SLot>> SLOT SELECTION

One selects the SLOT to be used with the analogue output: SLOT 1 or SLOT2; it is possible to indifferently use either SLOT.

<<ModE>> OPERATING MODE

AO G = analogue output on gross weight

AO n = analogue output on net weight

AO S = analogue output proportional to the dosing speed. One is asked to enter the (target-flight) percentage with which to start the slow part of the dosage. **Note:** the percentage will be the same for all the connected scales. To set the slow weight, **USER MAN REF.** 11.1.1 paragraph.

Once the functioning mode is confirmed, one sets the values of the analogue output; in other words, the digital/analogue converter values are entered (between 0 and 65535) to which corresponds a certain output value in voltage or in current.

In this configuration the instrument keys take on the following meanings (functions):

ENTER By pressing once after a value is entered, it activates the corresponding output analogue value, (allowing the check) but the step still remains inside in case of a new modification. By pressing a second time (on the same entered value) it confirms and exits the step.

C Allows to quickly zero the present value.

<<AoMA>> MAXIMUM VALUE

By entering this step, one sets the maximum value of the analogue output, in other words the corresponding value of the

full scale capacity. This value can be anywhere between 0 and 65535 (values of the digital/analogue converter); if a higher digit is entered, the instrument emits a prolonged sound, after which it zeros the value just entered.

<<AoZE>> SCALE ZERO VALUE

By entering this step, one sets the analogue output value when the scale displays zero weight. This value can be anywhere between 0 and 65535 (values of the digital/analogue converter); if a higher digit is entered, the instrument emits a prolonged sound, after which it zeros the value just entered.

<<AoMi>> MINIMUM VALUE

By entering this step, one sets the minimum value of the analogue output. This value can be anywhere between 0 and 65535 (values of the digital/analogue converter); if a higher digit is entered, the instrument emits a prolonged sound, after which it zeros the value just entered.

APPROXIMATE VALUES BETWEEN THE D/A CONVERTER AND ANALOGUE OUTPUT

D/A CONVERTER VALUES	VOLTAGE VALUE (V)	CURRENT VALUE (mA)
1200	0	0
12700		4
58600		20
62650	10	

10. PROGRAMMING THE PRINTOUTS

It is possible to programme 27 different print formats, linked to the 27 available print functions (see section 14, **USER.MAN.REF.**):

- "Prn.F.1" format >> simple printout
- "Prn.F.2" format >> headers
- ...

For the complete list of the functions and the linked formats, see the "PRINTOUTS" section of the **USER MANUAL**.

It is possible to configure the formats:

- **through the Dinitools™ software** for PC, and transmitted to the indicator through the serial line; it is necessary that the print format number ("Print Format Number") is a value between 1 and 11 to indicate the format to be overwritten.
- **manually from the indicator** by entering in the **SetuP >> SeriAL >> Prn.FMt** step inside the SET-UP environment.

MANUAL CONFIGURATION OF THE PRINT FORMATS

Each ticket is made up of a maximum of 2048 memory storages (which we will call "lines", from 0 to 2047; only the first 1000 are manually modifiable from the indicator), which, when programmed, these will produce the desired printout; in each line one can enter (through a 3-digit code, from 300 onwards) a command named "print block", which will produce a certain type of printout, for example:

PRINT NET WEIGHT (code 307), which will print the net weight value, the unit of measure and the CR or CR LF to go to the next line.

Or it is possible to print a single alphanumeric character, entering the relative ASCII code in the line (from 0 to 255).

To configure a print format:

- Enter in the **SetuP >> SeriAL >> Prn.FMt** parameter.
- The display shows:

C.F. XX in which:

XX indicates the number of the format to be modified (from 01 to 30)

- Select the print format to be configured using the arrow keys **▲ ▼** and press the **ENTER** key
- Once entered in a format (for example C.F. 01), the display shows:

XXX.YYY in which:

XXX is number of the line which one is programming.

YYY is the entered code (from 0 to 255 the ASCII code is printed, from 300 onwards the relative block is printed).

- Select the line to be programmed using the arrow keys **▲ ▼**, or by typing the line number through the numeric keyboard, and press the **ENTER** key.
- The display shows "CHANGE" for an instant and onwards:

XXX in which:

XXX is the value to be modified.

- Enter a value and press the **ENTER** key to confirm; the **C** key clears the entered value and if pressed again it cancels the operation.
- If a print block with parameters from 600 onwards has been entered, after having pressed the **ENTER** key the displays shows:

XXX in which:

XXX is the value to be modified.

- Enter a valid value and press the **ENTER** key to confirm.
- Once programmed all the desired lines one should enter in the last line block 300 (PRINT END); Press the **C** key to exit; the display will show the saving request; press the **ENTER** key to confirm or another key to cancel.

KEYS' FUNCTIONS

- ▲ scrolls forward inside the lines of the print format.
- ▼ scrolls backward inside the lines of the print format.
- F1** enters a print block or an ASCII character in the selected line moving the consecutive blocks of one place.
- F2** cancels the current line compacting the blocks that follow.
- F3** enters a print end in the current line.
- ENTER** modifies the code in the current line; while entering it confirms the entered code.
- C** exits the programming; one is asked to save (the display shows "SAVE?"): with **ENTER** one confirms, with another key one exits without saving. While entering a code, it quickly zeros the present value.

NUMERICAL

- KEYBOARD** allows entering a code inside of the selected printing line.

NOTES

- For the complete list of the ASCII codes and the print blocks, see the sections 10.2 and 10.3.
- To terminate the programming of a format, it is necessary that the last command be "Print end": one should enter the code 300 (or press the **F3** key) in the last line of the format.

PRINTING ON THE PC SERIAL PORT

By programming correctly a format, it is possible to direct the printing on the PC serial port, and then bring it back onto the printer port; the blocks to be used are:

312 (PRINTING ON PC PORT), 313 (PRINTING ON SERIAL PORT), 314 (FORCES THE PRINTING).

The correct syntax in the format is the following:

- **312 PRINTS ON PC PORT**
- prints block or ASCII character
- ...
- **314 FORCES PRINTING**
- **313 PRINTS ON PRINTER PORT**
- prints block or ASCII character
- ...
- **314 FORCES PRINTING**
- 300 PRINT END

The "Forces print" block executes the transmission of all the blocks or ASCII characters entered BEFORE the same block; reading block 312, the printout is directed onto the PC port.

All the blocks or ASCII characters entered here are instead transmitted through the printer serial port.

10.1 PROGRAMMING EXAMPLE

One programmes a format to be linked to a PRINT key function (**S.F.01** function) in this way:

MARIO ROSSI SRL	MARIO ROSSI SRL
Date – time	1/02/2005 – 19:00:00
Gross weight	GROSS 2.000kg
Tare weight	TARE 0.000kg
Net weight	NET 2.000kg
3 CRLF	
Print end	

After having entered in the SET-UP environment, follow the procedures below:

- Go to step "**Prn.F.1**", inside the "SERIAL" parameter of the "SETUP" step and press **ENTER**: the display shows "**000.xxx**" (first line number, macro code).
- Press **ENTER**, the display shows "**xxx (macro code)**": enter the 077 code (ASCII relative to the "M" letter), confirm with **ENTER**.

- The display now shows "001.xxx " (second line number, fine macro code), press **ENTER** and enter the 065 code (ASCII relative to the letter "A"); confirm with **ENTER** to pass to the third line.

- Repeat the operations by entering the following codes:

082 (letter "R")

073 (letter "I")

079 (letter "O")

032 (space)

082 (letter "R")

079 (letter "O")

083 (letter "S")

083 (letter "S")

073 (letter "I")

032 (space)

083 (letter "S")

082 (letter "R")

076 (letter "L")

377 (print terminator)

013 (CR, Carriage Return)

362 (prints date – time)

308 (prints gross weight)

307 (prints net weight)

309 (prints tare weight)

328 (prints 3 CRLF)

300 (print end)

**** It is possible to enter the print end also with the F3 key ****

- Press the **C** key to exit the programming: the display shows "SAVE?", confirm with **ENTER** (one goes back into the "SERIAL" parameter).

- Exit the SETUP environment of the instrument by pressing the **C** key various times: the display shows "SAVE?", confirm the changes made with **ENTER** (the instrument returns to weighing).

- Link the configured format to the print key function (see the "PRINTOUTS" section of the user manual).

10.2 ASCII CODE TABLE

10.2.1 Windows 1252 (Latin1)

	00	01	02	03	04	05	06	07	08	09	0A	0B	0C	0D	0E	0F
00	<u>NUL</u> 0000	<u>SOH</u> 0001	<u>STX</u> 0002	<u>ETX</u> 0003	<u>EOT</u> 0004	<u>ENQ</u> 0005	<u>ACK</u> 0006	<u>BEL</u> 0007	<u>BS</u> 0008	<u>HT</u> 0009	<u>LF</u> 000A	<u>VT</u> 000B	<u>FF</u> 000C	<u>CR</u> 000D	<u>SO</u> 000E	<u>SI</u> 000F
10	<u>DLE</u> 0010	<u>DC1</u> 0011	<u>DC2</u> 0012	<u>DC3</u> 0013	<u>DC4</u> 0014	<u>NAK</u> 0015	<u>SYN</u> 0016	<u>ETB</u> 0017	<u>CAN</u> 0018	<u>EM</u> 0019	<u>SUB</u> 001A	<u>ESC</u> 001B	<u>FS</u> 001C	<u>GS</u> 001D	<u>RS</u> 001E	<u>US</u> 001F
20	<u>SP</u> 0020	!	"	#	\$	%	&	'	()	*	+	,	-	.	/
30	0	1	2	3	4	5	6	7	8	9	:	;	<	=	>	?
40	@	A	B	C	D	E	F	G	H	I	J	K	L	M	N	O
50	P	Q	R	S	T	U	V	W	X	Y	Z	[\]	^	_
60	`	a	b	c	d	e	f	g	h	i	j	k	l	m	n	o
70	p	q	r	s	t	u	v	w	x	y	z	{		}	~	<u>DEL</u> 007F
80	€ 20AC	⋯	/	f	„	…	†	‡	ˆ	%	š	<	Œ	⋯	Ž	⋯
90	⋯	\	/	“	”	•	—	—	˜	™	š	>	œ	⋯	ž	ÿ
A0	<u>NBSP</u> 00A0	¡	¢	£	¤	¥	¦	§	¨	@	ª	«	¬	­	®	¯
B0	°	±	²	³	´	µ	¶	·	¸	¹	º	»	¼	½	¾	¿
C0	À	Á	Â	Ã	Ä	Å	Æ	Ç	È	É	Ê	Ë	Ì	Í	Î	Ï
D0	Ð	Ñ	Ò	Ó	Ô	Õ	Ö	×	Ø	Ù	Ú	Û	Ü	Ý	Þ	ß
E0	à	á	â	ã	ä	å	æ	ç	è	é	ê	ë	ì	í	î	ï
F0	ð	ñ	ò	ó	ô	õ	ö	÷	ø	ù	ú	û	ü	ý	þ	ÿ

10.2.2 Windows 1251 (Cyrillic)

	00	01	02	03	04	05	06	07	08	09	0A	0B	0C	0D	0E	0F
00	<u>NUL</u> 0000	<u>SOH</u> 0001	<u>STX</u> 0002	<u>ETX</u> 0003	<u>EOT</u> 0004	<u>ENQ</u> 0005	<u>ACK</u> 0006	<u>BEL</u> 0007	<u>BS</u> 0008	<u>HT</u> 0009	<u>LF</u> 000A	<u>VT</u> 000B	<u>FF</u> 000C	<u>CR</u> 000D	<u>SO</u> 000E	<u>SI</u> 000F
10	<u>DLE</u> 0010	<u>DC1</u> 0011	<u>DC2</u> 0012	<u>DC3</u> 0013	<u>DC4</u> 0014	<u>NAK</u> 0015	<u>SYN</u> 0016	<u>ETB</u> 0017	<u>CAN</u> 0018	<u>EM</u> 0019	<u>SUB</u> 001A	<u>ESC</u> 001B	<u>FS</u> 001C	<u>GS</u> 001D	<u>RS</u> 001E	<u>US</u> 001F
20	<u>SP</u> 0020	! 0021	" 0022	# 0023	\$ 0024	% 0025	& 0026	' 0027	(0028) 0029	* 002A	+ 002B	, 002C	- 002D	. 002E	/ 002F
30	0 0030	1 0031	2 0032	3 0033	4 0034	5 0035	6 0036	7 0037	8 0038	9 0039	: 003A	; 003B	< 003C	= 003D	> 003E	? 003F
40	@ 0040	A 0041	B 0042	C 0043	D 0044	E 0045	F 0046	G 0047	H 0048	I 0049	J 004A	K 004B	L 004C	M 004D	N 004E	O 004F
50	P 0050	Q 0051	R 0052	S 0053	T 0054	U 0055	V 0056	W 0057	X 0058	Y 0059	Z 005A	[005B	\ 005C] 005D	^ 005E	_ 005F
60	` 0060	a 0061	b 0062	c 0063	d 0064	e 0065	f 0066	g 0067	h 0068	i 0069	j 006A	k 006B	l 006C	m 006D	n 006E	o 006F
70	p 0070	q 0071	r 0072	s 0073	t 0074	u 0075	v 0076	w 0077	x 0078	y 0079	z 007A	{ 007B	 007C	}	~ 007E	<u>DEL</u> 007F
80	Ѡ 0402	ѡ 0403	Ѣ 201A	ѣ 0453	Ѥ 201E	ѥ 2026	Ѧ 2020	ѧ 2021	Ѩ 20AC	ѩ 2030	Ѫ 0409	ѫ 2039	Ѭ 040A	ѭ 040C	Ѯ 040B	ѯ 040F
90	Ѱ 0452	ѱ 2018	Ѳ 2019	ѳ 201C	Ѵ 201D	ѵ 2022	Ѷ 2013	ѷ 2014	Ѹ 2122	ѹ 0459	Ѻ 203A	ѻ 045A	Ѽ 045C	ѽ 045B	Ѿ 045F	
A0	<u>NBSP</u> 00A0	ѿ 040E	Ѡ 045E	ѡ 0408	Ѣ 00A4	ѣ 0490	Ѥ 00A6	ѥ 00A7	Ѧ 0401	ѧ 00A9	Ѩ 0404	ѩ 00AB	Ѫ 00AC	ѫ 00AD	Ѭ 00AE	ѭ 0407
B0	Ѯ 00B0	ѯ 00B1	Ѱ 0406	ѱ 0456	Ѳ 0491	ѳ 00B5	Ѵ 00B6	ѵ 00B7	Ѷ 0451	ѷ 2116	Ѹ 0454	ѹ 00BB	Ѻ 0458	ѻ 0405	Ѽ 0455	ѽ 0457
C0	Ѿ 0410	ѿ 0411	Ѡ 0412	ѡ 0413	Ѣ 0414	ѣ 0415	Ѥ 0416	ѥ 0417	Ѧ 0418	ѧ 0419	Ѩ 041A	ѩ 041B	Ѫ 041C	ѫ 041D	Ѭ 041E	ѭ 041F
D0	Ѯ 0420	ѯ 0421	Ѱ 0422	ѱ 0423	Ѳ 0424	ѳ 0425	Ѵ 0426	ѵ 0427	Ѷ 0428	ѷ 0429	Ѹ 042A	ѹ 042B	Ѻ 042C	ѻ 042D	Ѽ 042E	ѽ 042F
E0	Ѿ 0430	ѿ 0431	Ѡ 0432	ѡ 0433	Ѣ 0434	ѣ 0435	Ѥ 0436	ѥ 0437	Ѧ 0438	ѧ 0439	Ѩ 043A	ѩ 043B	Ѫ 043C	ѫ 043D	Ѭ 043E	ѭ 043F
F0	Ѯ 0440	ѯ 0441	Ѱ 0442	ѱ 0443	Ѳ 0444	ѳ 0445	Ѵ 0446	ѵ 0447	Ѷ 0448	ѷ 0449	Ѹ 044A	ѹ 044B	Ѻ 044C	ѻ 044D	Ѽ 044E	ѽ 044F

10.2.3 Windows 1253 (Greek)

	00	01	02	03	04	05	06	07	08	09	0A	0B	0C	0D	0E	0F
00	<u>NUL</u> 0000	<u>SOH</u> 0001	<u>STX</u> 0002	<u>ETX</u> 0003	<u>EOT</u> 0004	<u>ENQ</u> 0005	<u>ACK</u> 0006	<u>BEL</u> 0007	<u>BS</u> 0008	<u>HT</u> 0009	<u>LF</u> 000A	<u>VT</u> 000B	<u>FF</u> 000C	<u>CR</u> 000D	<u>SO</u> 000E	<u>SI</u> 000F
10	<u>DLE</u> 0010	<u>DC1</u> 0011	<u>DC2</u> 0012	<u>DC3</u> 0013	<u>DC4</u> 0014	<u>NAK</u> 0015	<u>SYN</u> 0016	<u>ETB</u> 0017	<u>CAN</u> 0018	<u>EM</u> 0019	<u>SUB</u> 001A	<u>ESC</u> 001B	<u>FS</u> 001C	<u>GS</u> 001D	<u>RS</u> 001E	<u>US</u> 001F
20	<u>SP</u> 0020	!	"	#	\$	%	&	'	()	*	+	,	-	.	/
30	0	1	2	3	4	5	6	7	8	9	:	;	<	=	>	?
40	@	A	B	C	D	E	F	G	H	I	J	K	L	M	N	O
50	P	Q	R	S	T	U	V	W	X	Y	Z	[\]	^	_
60	`	a	b	c	d	e	f	g	h	i	j	k	l	m	n	o
70	p	q	r	s	t	u	v	w	x	y	z	{		}	~	<u>DEL</u> 007F
80	€ 20AC		/	f	#	...	†	‡		%		<				
90		\	/	"	"	•	—	—		™		>				
A0	<u>NBSP</u> 00A0	ˆ	À	£	※	¥	¡	§	¨	©		«	¬	—	®	—
B0	°	±	²	³	´	µ	¶	·	È	É	Ê	»	Ï	¼	Ý	Ω
C0	í	Α	Β	Γ	Δ	Ε	Ζ	Η	Θ	Ι	Κ	Λ	Μ	Ν	Ξ	Ο
D0	Π	Ρ		Σ	Τ	Υ	Φ	Χ	Ψ	Ω	Ϊ	Ϋ	ά	έ	ή	ί
E0	ύ	α	β	γ	δ	ε	ζ	η	θ	ι	κ	λ	μ	ν	ξ	ο
F0	π	ρ	ς	σ	τ	υ	φ	χ	ψ	ω	ϊ	ϋ	ό	ύ	ώ	

10.3 LIST OF PRINT BLOCKS

LEGEND:

- b** indicates a space character (ASCII 32 decimal character).
- UM** unit of measure of the active scale (kg, **bg**, **bt**, lb).
- + T** terminator: depending on the setting of the << **tErMin** >> step, a CR or CRLF is added, or no terminator.
- XXX*** These blocks do not work without the alibi memory (optional).

The weight fields expand from right to left, with spaces (ASCII 32 decimal character) to complete the field length.

10.3.1 ORDER BY KIND

CODE	GENERIC	PRINT FORMAT
364	ONLY HEADING OF LINE 1	XXXXXXXXXXXXXXXXXXXXXXXXXXXX + T
365	ONLY HEADING OF LINE 2	XXXXXXXXXXXXXXXXXXXXXXXXXXXX + T
366	ONLY HEADING OF LINE 3	XXXXXXXXXXXXXXXXXXXXXXXXXXXX + T
	in which XXXXXXXXXXXXXXXXXXXXXXX are the 24 characters of the first line of the heading; just the entered characters are printed, from left to right.	
310	DOTTED LINE	----- + T
436	PRINTS 3 CRLF	
363	SKIPS FOLLOWING MACRO TERMINATOR	
377	PRINTS TERMINATOR	CR or CRLF or NO TERMINATOR
311	DATE / TIME FOR DP24/DP190	b HH:MM b DD-MM-YY + T
360	INDICATOR DATE	DD/MM/YY
361	INDICATOR TIME	HH:MM:SS
362	INDICATOR DATE TIME	DD/MM/YY b HH:MM:SS
441	INDICATOR TIME	HHMMSS
442	INDICATOR DATE	YYMMDD
381	JUST DATE OF LAST ZEROING OF GENERAL TOTAL	DD/MM/YY
417	JUST DATE OF LAST ZEROING OF FORMULA TOTAL	DD/MM/YY

437	ACTIVE SCALE NUMBER in which X is the active scale number (0..4)	SX + T
425	JUST NUMBER OF SCALE IN USE	X
424	JUST SCALE UNIT OF MEASURE IN USE The field expands from right to left.	UM
373	JUST DATABASE UNIT OF MEASURE The field expands from right to left.	UM
370	ACTIVE SCALE NUMBER in which X is the active scale number (0..4)	SCALEbNUMBERbX + T
371	JUST ACTIVE SCALE NUMBER in which X is the active scale number (0..4)	X
372	SCALE UNIT OF MEASURE	UM + T
401	DATABASE UNIT OF MEASURE	UM
312	PRINTS ON PC PORT	
313	PRINTS ON PRINTER PORT	
314	FORCES PRINTOUT	
375	STANDARD KD PROTOCOL STRING	
376	AFX PROTOCOL STRING By using blocks 375 and 376 it is possible to print the STANDARD or AFX serial string (see 8.4 TRANSMISSION PROTOCOLS section for the description); the string terminator is the one set in the tErMin "SET TERMINATOR TYPE" step in the SET-UP environment (CR or CRLF or no terminator).	
428	ONLY YEAR IN YY FORMAT	YY
429	ONLY MONTH IN MM FORMAT	MM

- 430 ONLY DAY IN DD FORMAT DD
- 431 ONLY HOUR IN HH FORMAT HH
- 432 ONLY THE MINUTES IN MM FORMAT MM

CURRENT WEIGHT ON THE SCALE

- 307 NET WEIGHT NET=XXXXXXXXXUM + T
current net weight on the weighing system
- 301 JUST NET ON 8 DIGITS XXXXXXXX
- 368 JUST NET ON 10 DIGITS XXXXXXXXXXXX

- 308 GROSS WEIGHT GROSS=XXXXXXXXXUM + T
current gross weight on the weighing system
- 302 JUST GROSS 8 DIGITS XXXXXXXX
- 367 JUST GROSS ON 10 DIGITS XXXXXXXXXXXX
the field expands from right to left, with many spaces for completing the field length.
- 309 TARE WEIGHT TARE=XXXXXXXXXUM + T
in which XXXXXXXXXXXX is the value of the current weight on the weighing system. Upon 8 digits including the comma; the field expands from right to left
- 303 JUST TARE 8 DIGITS XXXXXXXX
- 369 JUST TARE ON 10 DIGITS XXXXXXXXXXXX
- 438 JUST CURRENT NET WEIGHT VALUE XXXXXXXXXXXX
- 440 JUST CURRENT TARE WEIGHT VALUE XXXXXXXXXXXX
in which XXXXXXXXXXXX is the value of the weight on the weight system, in 10 digits including the comma; the field expands from right to left.
- 439 JUST CURRENT GROSS WEIGHT VALUE XXXXXXXXXXXX

DOSAGE

- 408 TARGET DOSEXXXXXXXXXXUM + T
in which XXXXXXXXXXXX is the weight value on 10 digits including the comma (the field expands from right to left, with many spaces for completing the length of the field); UM indicates the unit of measure of the scale.
- 461 FORMULA TARGET TARGET**bbbbbb**XXXXXXXXXUM + T
in which XXXXXXXX is the weight value on 8 digits including the comma (the field expands from right to left, with many spaces for completing the length of the field); UM indicates the unit of measure of the archive.
- 463 DOSED WEIGHT DOSED WEIGHT**bbbbbb**XXXXXXXXXUM + T
in which XXXXXXXX is the weight value on 8 digits including the comma (the field expands from right to left, with many spaces for completing the length of the field); UM indicates the unit of measure of the scale
- 468 FIRST PRODUCTION TARGET CONTENT **YYYbb**XXXXXXXXXXXXXXXXXXXXXXXXXAAAAAAAAUM + T
in which YYY is formula number, XXXXXXXXXXXXXXXXXXXX is 16 characters of formula description, AAAAAAAAA is the weight value on 8 digits including the comma (the field expands from right to left, with many spaces for completing the length of the field); UM indicates the unit of measure of the scale.
- 469 SECOND PRODUCTION TARGET CONTENT **YYYbb**XXXXXXXXXXXXXXXXXXXXXXXXXAAAAAAAAUM + T
- 470 THIRD PRODUCTION TARGET CONTENT **YYYbb**XXXXXXXXXXXXXXXXXXXXXXXXXAAAAAAAAUM + T
- 471 FOURTH PRODUCTION TARGET CONTENT **YYYbb**XXXXXXXXXXXXXXXXXXXXXXXXXAAAAAAAAUM + T
- 462 LAST DOSED WEIGHT DOSED WEIGHT**bbbbbb**XXXXXXXXXUM + T
It is the last net weight actually dosed, in which XXXXXXXX is the weight value on 8 digits including the comma (the field expands from right to left, with many spaces for completing the length of the field); UM indicates the unit of measure of the archive
- 392 LAST TOTAL DOSED WEIGHT AND TARE TARE**b**XXXXXXXXXUM + T

- 403 LAST TOTAL DOSED WEIGHT DOSED CYCLEXXXXXXXXXUM
- 476 TOTAL PRODUCTION TARGET TOTAL**bbbbbb**XXXXXXXXXUM + T
in which XXXXXXXX is the weight value on 8 digits including the comma (the field expands from right to left, with many spaces for completing the length of the field); UM indicates the unit of measure of the scale.

477	TOTAL PRODUCTION DOSED WEIGHT XXXXXXXX is the dosed material value on 8 digits including the comma (the field expands from right to left, with many spaces for completing the length of the field); UM indicates the unit of measure of the scale.	DOSED bbbbbbbb XXXXXXXXXUM + T
472	FIRST PRODUCTION DOSED CONTENT in which YYY is formula number, XXXXXXXXXXXXXXXXXXXX is 16 characters of formula description, BBBBBBBB is the dosed material value on 8 digits including the comma (the field expands from right to left, with many spaces for completing the length of the field); UM indicates the unit of measure of the scale.	YYY bb XXXXXXXXXXXXXXXXXXXXBBBBBBBUM + T
473	SECOND PRODUCTION DOSED CONTENT	YYY bb XXXXXXXXXXXXXXXXXXXXBBBBBBBUM + T
474	THIRD PRODUCTION DOSED CONTENT	YYY bb XXXXXXXXXXXXXXXXXXXXBBBBBBBUM + T
475	FOURTH PRODUCTION DOSED CONTENT	YYY bb XXXXXXXXXXXXXXXXXXXXBBBBBBBUM + T
402	JUST LAST TOTAL DOSED WEIGHT The field expands from right to left, with many spaces for completing the length of the field	XXXXXXXXXX
411	JUST SELECTED FORMULA TARGET VALUE The field expands in 8 digits, from right to left; the target is printed just during the execution of the dosage.	XXXXXXXX
412	JUST DOSED TOTAL OF SELECTED FORMULA The field expands on 8 digits, from right to left; blank spaces are printed to complete the field.	XXXXXXXX
413	JUST OUT OF TOLERANCE DOSED TOTAL OF SELECTED FORMULA The field expands in 8 digits, from right to left; the target is printed just during the execution of the dosage.	XXXXXXXX
391	JUST DOSED GENERAL TOTAL The field expands on 8 digits, from right to left, blank spaces are printed to complete the field.	XXXXXXXX
389	JUST GENERAL TOTAL DOSED OUT OF TOLERANCE The field expands on 8 digits, from right to left; blank spaces are printed to complete the field.	XXXXXXXX
390	JUST GENERAL TOTAL DOSED WITHIN TOLERANCE The field expands on 8 digits, from right to left; blank spaces are printed to complete the field.	XXXXXXXX;
420	JUST TOTAL DOSED WITHIN TOLERANCE FOR SELECTED FORMULA The field expands on 8 digits, from right to left; blank spaces are printed to complete the field.	XXXXXXXX
387	CYCLES TOTALS	TARGETXXXXXXXXXUM DOSEDXXXXXXXXXUM OUT OF TOL.XXXXXXXXXXUM + T
388	CYCLE TOTALS	TARGETXXXXXXXXXUM DOSEDXXXXXXXXXUM OUT OF TOL.XXXXXXXXXXUM + T
	in which TARGET is the TOTAL CYCLES/CYCLE PROGRAMMED, DOSED the TOTAL CYCLES/CYCLE MADE, OUT OF TOL the TOTAL CYCLES/CYCLE OUT OF CAPACITY; XXXXXXXXXXXX is the weight value on 10 digits including the comma (the field expands from right to left, with many spaces for completing the length of the field); UM indicates the scale's unit of measure..	
406	TYPE OF ACTIVITY	0 x MANUAL DOS. bbb 0 x AUTOMATIC DOS. b 0 x MANUAL b WEIGHT b 0 x UNLOAD bbbbbbbb 0 x TIMER bbbbbbbb 0 x WAIT bbbbbbbb
	The text varies depending on the type of activity carried out.	
422	JUST TYPE OF ACTIVITY DESCRIPTION	MAN. DOSAGE or AUTOMATIC DOS. or MANUAL WEIGHT or UNLOADING
	The text varies depending on the type of activity made.	
423	ONLY PROGRESSIVE OF EXECUTED ACTIVITIES	0 X
	In which X can take on two different values depending on the type of activity made: 1 automatic or manual dosage, 2 for unloading.	
386	PARTIAL UNLOADING END	UNLOADED bb XXXXXXXXXUM + T

405	FORMULA DESCRIPTION	FORMULAbXXXXXXXXXXXXXXXXXXXXX + T
	in which XXXXXXXXXXXXXXXXXXXX are the 20 description characters of the selected formula; just the entered characters are printed, from right to left.	
407	ONLY DESCRIPTION OF ACTIVITY	XXXXXXXXXXXXXXXXXXXXX
410	JUST FORMULA DESCRIPTION	XXXXXXXXXXXXXXXXXXXXX
404	CYCLE REPORT	CYCLEbREPORTbXX/YY + T
	in which XX indicates the number of dosages made, YY indicates the number of programmed cycle repetitions.	
409	ONLY NUMBER OF LAST CYCLE MADE	XXX
	It is the last complete cycle made; the field expands on three digits and also the non significant zeros are printed	
478	THE NUMBER OF PRODUCTION FORMULA	PRODUCTION FORMULA:bX + T
	In which X is active production formula number.	
421	JUST CURRENT CYCLE NUMBER	XXX
	It is the cycle in execution; the field expands on three digits and also the non significant zeros are printed.	
415	JUST TOTAL OF CYCLES MADE FOR SELECTED FORMULA	XXXXX
416	JUST TOTAL OF WRONG CYCLES FOR SELECTED FORMULA	XXXXX
380	JUST GENERAL TOTAL OF CYCLES MADE	XXXXX
378	JUST GENERAL TOTAL OF WRONG CYCLES	XXXXX
	The field expands on 5 digits, from right to left; blank spaces are printed to complete the field.	
419	JUST TOTAL OF CYCLES WITHIN TOLERANCE FOR SELECTED FORMULA	XXXXX
379	JUST TOTAL OF CYCLES IN TOLERANCE FOR GENERAL TOTAL	XXXXX
	The field expands on 5 digits, from right to left.	
418	JUST NUMBER OF REPETITIONS OF SELECTED FORMULA	XXX
	The field expands on three digits, from right to left; also the non significant zeros are printed.	
414	JUST ERROR TOTAL IN DOSAGES WITHIN TOLERANCE FOR FORMULA TOTAL	XXXXXXXX
	The field expands on 8 digits from right to left; This field prints the algebraic sum of the difference between the dosed weight and the set target (the error) of each executed dosage activity. The block refers to the active formula.	
382	JUST GENERAL ERROR TOTAL IN THE DOSAGES WITHIN TOLERANCE	XXXXXXXX
	The field expands on 8 digits, from left to right This field prints the algebraic sum of the difference between the dosed weight and the set target (the error) of each executed dosage activity. The block refers to the active formula.	
479	JUST FIRST PRODUCTION FORMULA NUMBER	XXX
	In which XXX is formula number.	
483	JUST SECOND PRODUCTION FORMULA NUMBER	XXX
487	JUST THIRD PRODUCTION FORMULA NUMBER	XXX
491	JUST FOURTH PRODUCTION FORMULA NUMBER	XXX
480	JUST FIRST PRODUCTION FORMULA DESCRIPTION	XXXXXXXXXXXXXXXXXXXXX
	In which XXXXXXXXXXXXXXXXXXXX is 16 characters of formula description.	
484	JUST SECOND PRODUCTION FORMULA DESCRIPTION	XXXXXXXXXXXXXXXXXXXXX
488	JUST THIRD PRODUCTION FORMULA DESCRIPTION	XXXXXXXXXXXXXXXXXXXXX
492	JUST FOURTH PRODUCTION FORMULA DESCRIPTION	XXXXXXXXXXXXXXXXXXXXX
481	JUST FIRST PRODUCTION TARGET WITH UNIT OF MEASURE	XXXXXXXXXUM
	in which XXXXXXXX is the weight value on 8 digits including the comma (the field expands from right to left, with many spaces for completing the length of the field); UM indicates the unit of measure of the scale.	
485	JUST SECOND PRODUCTION TARGET WITH UNIT OF MEASURE	XXXXXXXXXUM
489	JUST THIRD PRODUCTION TARGET WITH UNIT OF MEASURE	XXXXXXXXXUM
493	JUST FOURTH PRODUCTION TARGET WITH UNIT OF MEASURE	XXXXXXXXXUM
482	JUST FIRST PRODUCTION DOSED WEIGHT WITH UNIT OF MEASURE	XXXXXXXXXUM
	in which XXXXXXXX is the dosed material value on 8 digits including the comma (the field expands from right to left, with many spaces for completing the length of the field); UM indicates the unit of measure of the scale.	
486	JUST SECOND PRODUCTION DOSED WEIGHT WITH UNIT OF MEASURE	XXXXXXXXXUM
490	JUST THIRD PRODUCTION DOSED WEIGHT WITH UNIT OF MEASURE	XXXXXXXXXUM
494	JUST FOURTH PRODUCTION DOSED WEIGHT WITH UNIT OF MEASURE	XXXXXXXXXUM

426 ONLY DOSED WEIGHT ERROR FOR SELECTED FORMULA XXXXXXXX
 The block expands from right to left; just the significant digits are printed.

385 ACTIVITY END LOADING DOSEbXXXXXXXXUM
 DOSEDbXXXXXXXXUM + T
 UNLOADING UNLOADEDbbXXXXXXXXXUM + T
 MANUAL DOSAGE DEMXXXXXXXXUM + T
 TIMER ADDXXXXXXXXUMbbdosed:XXXXXX
 PAUSE ADDXXXXXXXXUMbbdosed:XXXXXX

NOTE: For the TIMER and PAUSE activities, the macro is printed only if one has enabled the sum of the eventual dosed weight at the end of these activities together with the dosed total weight, in the **Add.t** and **Add.P** parameters, TECH.MAN.REF.

427 ONLY ACTIVITY END WEIGHT XXXXXXXX
 The field expands on 8 digits, from right to left; blank spaces are printed to complete the field.
NOTE: For the TIMER and PAUSE activities, the macro is printed only if one has enabled the sum of the eventual dosed weight at the end of these activities together with the dosed total weight, in the **Add.t** and **Add.P** parameters, TECH.MAN.REF.

460 ONLY LAST DOSED WEIGHT XXXXXXXX
 It is the last net weight actually dosed, in which XXXXXXXX is the weight value on 8 digits including the comma (the field expands from right to left, with many spaces for completing the length of the field).

435 TIMER ACTIVITY TIMES TARGETbbbbbbbbbXXXXX.Xs
 ELAPSEDbbbbbbbbbXXXXX.Xs + T
 In witch TARGET is the programmed time, ELAPSED is the elapsed time and "s" is the unit of measure (seconds).

INPUT TEXTS

315 JUST INPUT 0 TEXT HEADING XXXXXXXXXXXXXXXXXXXX
 in which XXXXXXXXXXXXXXXXXXXX are 16 characters of the input 0 text heading; just the entered characters are printed, from left to right.

316 JUST INPUT 1 TEXT HEADING XXXXXXXXXXXXXXXXXXXX

317 JUST INPUT 2 TEXT HEADING XXXXXXXXXXXXXXXXXXXX

318 JUST INPUT 3 TEXT HEADING XXXXXXXXXXXXXXXXXXXX

319 JUST INPUT 4 TEXT HEADING XXXXXXXXXXXXXXXXXXXX

320 JUST INPUT 5 TEXT HEADING XXXXXXXXXXXXXXXXXXXX

321 JUST INPUT 6 TEXT HEADING XXXXXXXXXXXXXXXXXXXX

322 JUST INPUT 7TEXT HEADING XXXXXXXXXXXXXXXXXXXX

323 JUST INPUT 8 TEXT HEADING XXXXXXXXXXXXXXXXXXXX

324 JUST INPUT 9 TEXT HEADING XXXXXXXXXXXXXXXXXXXX

325 JUST INPUT 10 TEXT HEADING XXXXXXXXXXXXXXXXXXXX

326 JUST INPUT 11 TEXT HEADING XXXXXXXXXXXXXXXXXXXX

327 JUST INPUT 12 TEXT HEADING XXXXXXXXXXXXXXXXXXXX

328 JUST INPUT 13 TEXT HEADING XXXXXXXXXXXXXXXXXXXX

329 JUST INPUT 14 TEXT HEADING XXXXXXXXXXXXXXXXXXXX

330 JUST THE INPUT 0 TEXT CONTENTS YYYYYYYYYYYYYYYYYYYYYYYYYYYYYYYYYYYY
 in which YYYYYYYYYYYYYYYYYYYYYYYYYYYYYYYYYYYY are 32 characters of the input 0 text contents; just the entered characters are printed, from left to right.

331 JUST THE INPUT 1 TEXT CONTENTS YYYYYYYYYYYYYYYYYYYYYYYYYYYYYYYYYYYY

332 JUST THE INPUT 2 TEXT CONTENTS YYYYYYYYYYYYYYYYYYYYYYYYYYYYYYYYYYYY

333 JUST THE INPUT 3 TEXT CONTENTS YYYYYYYYYYYYYYYYYYYYYYYYYYYYYYYYYYYY

334 JUST THE INPUT 4 TEXT CONTENTS YYYYYYYYYYYYYYYYYYYYYYYYYYYYYYYYYYYY

335 JUST THE INPUT 5 TEXT CONTENTS YYYYYYYYYYYYYYYYYYYYYYYYYYYYYYYYYYYY

336 JUST THE INPUT 6 TEXT CONTENTS YYYYYYYYYYYYYYYYYYYYYYYYYYYYYYYYYYYY

337 JUST THE INPUT 7 TEXT CONTENTS YYYYYYYYYYYYYYYYYYYYYYYYYYYYYYYYYYYY

338 JUST THE INPUT 8 TEXT CONTENTS YYYYYYYYYYYYYYYYYYYYYYYYYYYYYYYYYYYY

```

339 JUST THE INPUT 9 TEXT CONTENTS YYYYYYYYYYYYYYYYYYYYYYYYYYYYYYYYYYYY
340 JUST THE INPUT 10 TEXT CONTENTS YYYYYYYYYYYYYYYYYYYYYYYYYYYYYYYYYYYY
341 JUST THE INPUT 11 TEXT CONTENTS YYYYYYYYYYYYYYYYYYYYYYYYYYYYYYYYYYYY
342 JUST THE INPUT 12 TEXT CONTENTS YYYYYYYYYYYYYYYYYYYYYYYYYYYYYYYYYYYY
343 JUST THE INPUT 13 TEXT CONTENTS YYYYYYYYYYYYYYYYYYYYYYYYYYYYYYYYYYYY
344 JUST THE INPUT 14 TEXT CONTENTS YYYYYYYYYYYYYYYYYYYYYYYYYYYYYYYYYYYY
345 INPUT 0 TEXT XXXXXXXXXXXXXXXXXXXXbYYYYYYYYYYYYYYYYYYYYYYYYYYYYYYYYYYY + T
in which XXXXXXXXXXXXXXXXXXXX are 16 characters of the heading and
YYYYYYYYYYYYYYYYYYYYYYYYYYYYYYYYYYY are 32 characters of the input 0 text contents, just the entered
characters are printed, from left to right.
346 INPUT 1 TEXT XXXXXXXXXXXXXXXXXXXXbYYYYYYYYYYYYYYYYYYYYYYYYYYYYYYYYYYY + T
347 INPUT 2 TEXT XXXXXXXXXXXXXXXXXXXXbYYYYYYYYYYYYYYYYYYYYYYYYYYYYYYYYYYY + T
348 INPUT 3 TEXT XXXXXXXXXXXXXXXXXXXXbYYYYYYYYYYYYYYYYYYYYYYYYYYYYYYYYYYY + T
349 INPUT 4 TEXT XXXXXXXXXXXXXXXXXXXXbYYYYYYYYYYYYYYYYYYYYYYYYYYYYYYYYYYY + T
350 INPUT 5 TEXT XXXXXXXXXXXXXXXXXXXXbYYYYYYYYYYYYYYYYYYYYYYYYYYYYYYYYYYY + T
351 INPUT 6 TEXT XXXXXXXXXXXXXXXXXXXXbYYYYYYYYYYYYYYYYYYYYYYYYYYYYYYYYYYY + T
352 INPUT 7 TEXT XXXXXXXXXXXXXXXXXXXXbYYYYYYYYYYYYYYYYYYYYYYYYYYYYYYYYYYY + T
353 INPUT 8 TEXT XXXXXXXXXXXXXXXXXXXXbYYYYYYYYYYYYYYYYYYYYYYYYYYYYYYYYYYY + T
354 INPUT 9 TEXT XXXXXXXXXXXXXXXXXXXXbYYYYYYYYYYYYYYYYYYYYYYYYYYYYYYYYYYY + T
355 INPUT 10 TEXT XXXXXXXXXXXXXXXXXXXXbYYYYYYYYYYYYYYYYYYYYYYYYYYYYYYYYYYY + T
356 INPUT 11 TEXT XXXXXXXXXXXXXXXXXXXXbYYYYYYYYYYYYYYYYYYYYYYYYYYYYYYYYYYY + T
357 INPUT 12 TEXT XXXXXXXXXXXXXXXXXXXXbYYYYYYYYYYYYYYYYYYYYYYYYYYYYYYYYYYY + T
358 INPUT 13 TEXT XXXXXXXXXXXXXXXXXXXXbYYYYYYYYYYYYYYYYYYYYYYYYYYYYYYYYYYY + T
359 INPUT 14 TEXT XXXXXXXXXXXXXXXXXXXXbYYYYYYYYYYYYYYYYYYYYYYYYYYYYYYYYYYY + T
    
```

PRINTOUTS

```

446 ENABLES PAPER PRESENT SENSOR FOR TM295
447 RELEASES PAPER FOR TM295
448 EMISSION AND PAPER RELEASE FOR TM295
449 LARGE FONT FOR TM295 (2,5x6 mm - LxA)
450 MEDIUM SIZE FONT FOR TM295 (1,5x6 mm - LxA)
451 SMALL FONT FOR TM295 (1,5x3 mm - LxA)
452 MEDIUM SIZE FONT FOR LX300
453 LARGE FONT FOR LX300
454 SMALL FONT FOR LX300
455 LARGE FONT FOR DP190 (3x5 mm - LxA)
456 MEDIUM SIZE FONT FOR DP190 (1,5x5 mm - LxA)
457 SMALL FONT FOR DP190 (1,5x2,5 mm - LxA)
458 STARTS BARCODE 39 FOR THERMAL DP190
459 ENABLES TIME - OUT FOR TM295
    
```

PROGRESSIVES

```

374 TICKET PROGRESSIVE XXXXX
(progressive number that increases at every general total clearing)
the field expands from right tot left, with many spaces for completing the field length.
    
```

JUST TEXT

384	WEIGHT ERRORS ONLY TEXT	bWEIGHTbOUT OFbTOLERANCE + T WEIGHTbBEYONDbMAX.bTARE + T WEIGHTbBELOWbMIN. bTARE + T bbWEIGHTbOUTbOFbZERO + T bbUNSTABLEbWEIGHT + T ENDbOFbMAX bDOSAGEbTIME + T SCALEbOUTbOFbCAPACITY + T TIMERbALARM + T bbbbINTERRUPTEDbCYCLE + T
383	INTERRUPTED CYCLE ONLY TEXT	
395	JUST "ERROR" TEXT	
398	JUST "CYCLES TOTAL" TEXT	CYCLES TOTAL
464	JUST "CYCLE REPORT" TEXT	CYCLE REPORT
465	JUST "CYCLES REPORT" TEXT	CYCLES REPORT
393	JUST "OUT OF T. CYCLES" TEXT	CYCLES OFF
394	JUST "OK CYCLES" TEXT	CYCLES OK
400	JUST "GENERAL TOTAL" TEXT	GENERAL TOTAL
399	JUST "DOSED TOTAL" TEXT	DOSED TOTAL
396	JUST "OUT OF TOL." TEXT	OUT OF TOL.
397	JUST "IN TOLERANCE." TEXT	IN TOLERANCE
443	JUST "GROSS" TEXT	GROSS b
305	JUST "GROSS =" TEXT	GROSS b=
444	JUST "NET" TEXT	NET bbb
304	JUST "NET =" TEXT	NET bbb=
445	JUST "TARE" TEXT	TARE bb
306	JUST "TARE =" TEXT	TARE bb=
466	JUST "START PRODUCTION" TEXT	START PRODUCTION
467	JUST "END PRODUCTION" TEXT	END PRODUCTION
433	ONLY CONDITIONED TARE TEXT	XXXXXX
	XXXXXX becomes TARE bb when the tare is equal to 0 or semiautomatic, PT bbbb with manual tare.	
434	ONLY CONDITIONED PT TEXT	XX
	XX becomes bb with tare equal to 0 or semiautomatic, PT with manual tare.	

10.3.2 NUMERICAL ORDER

CODE		PRINT FORMAT
300	PRINT END	
301	JUST NET ON 8 DIGITS	XXXXXXXX
302	JUST NET GROSS 8 DIGITS	XXXXXXXX
303	JUST NET TARE 8 DIGITS	XXXXXXXX
304	JUST "NET =" TEXT	NET bbb=
305	JUST "GROSS =" TEXT	GROSS b=
306	JUST "TARE =" TEXT	TARE bb=
307	NET WEIGHT	NET=XXXXXXXXXUM + T
	current net weight on the weighing system	
308	GROSS WEIGHT	GROSS=XXXXXXXXXUM + T
	current gross weight on the weighing system	
309	TARE WEIGHT	TARE=XXXXXXXXXUM + T
	in which XXXXXXXXXXXX is the value of the current weight on the weighing system. Upon 8 digits including the comma; the field expands from right to left	
310	DOTTED LINE	----- + T
311	DATE / TIME FOR DP24/DP190	bHH:MMbDD-MM-YY + T
312	PRINTS ON PC PORT	
313	PRINTS ON PRINTER PORT	

```

314 FORCES PRINTOUT
315 JUST INPUT 0 TEXT HEADING XXXXXXXXXXXXXXXXXXXX
in which XXXXXXXXXXXXXXXXXXXX are 16 characters of the input 0 text heading; just the entered characters are
printed, from left to right.
316 JUST INPUT 1 TEXT HEADING XXXXXXXXXXXXXXXXXXXX
317 JUST INPUT 2 TEXT HEADING XXXXXXXXXXXXXXXXXXXX
318 JUST INPUT 3 TEXT HEADING XXXXXXXXXXXXXXXXXXXX
319 JUST INPUT 4 TEXT HEADING XXXXXXXXXXXXXXXXXXXX
320 JUST INPUT 5 TEXT HEADING XXXXXXXXXXXXXXXXXXXX
321 JUST INPUT 6 TEXT HEADING XXXXXXXXXXXXXXXXXXXX
322 JUST INPUT 7TEXT HEADING XXXXXXXXXXXXXXXXXXXX
323 JUST INPUT 8 TEXT HEADING XXXXXXXXXXXXXXXXXXXX
324 JUST INPUT 9 TEXT HEADING XXXXXXXXXXXXXXXXXXXX
325 JUST INPUT 10 TEXT HEADING XXXXXXXXXXXXXXXXXXXX
326 JUST INPUT 11 TEXT HEADING XXXXXXXXXXXXXXXXXXXX
327 JUST INPUT 12 TEXT HEADING XXXXXXXXXXXXXXXXXXXX
328 JUST INPUT 13 TEXT HEADING XXXXXXXXXXXXXXXXXXXX
329 JUST INPUT 14 TEXT HEADING XXXXXXXXXXXXXXXXXXXX
330 JUST THE INPUT 0 TEXT CONTENTS YYYYYYYYYYYYYYYYYYYYYYYYYYYYYYYYYYYY
in which YYYYYYYYYYYYYYYYYYYYYYYYYYYYYYYYYYYY are 32 characters of the input 0 text contents; just the
entered characters are printed, from left to right.
331 JUST THE INPUT 1 TEXT CONTENTS YYYYYYYYYYYYYYYYYYYYYYYYYYYYYYYYYYYY
332 JUST THE INPUT 2 TEXT CONTENTS YYYYYYYYYYYYYYYYYYYYYYYYYYYYYYYYYYYY
333 JUST THE INPUT 3 TEXT CONTENTS YYYYYYYYYYYYYYYYYYYYYYYYYYYYYYYYYYYY
334 JUST THE INPUT 4 TEXT CONTENTS YYYYYYYYYYYYYYYYYYYYYYYYYYYYYYYYYYYY
335 JUST THE INPUT 5 TEXT CONTENTS YYYYYYYYYYYYYYYYYYYYYYYYYYYYYYYYYYYY
336 JUST THE INPUT 6 TEXT CONTENTS YYYYYYYYYYYYYYYYYYYYYYYYYYYYYYYYYYYY
337 JUST THE INPUT 7 TEXT CONTENTS YYYYYYYYYYYYYYYYYYYYYYYYYYYYYYYYYYYY
338 JUST THE INPUT 8 TEXT CONTENTS YYYYYYYYYYYYYYYYYYYYYYYYYYYYYYYYYYYY
339 JUST THE INPUT 9 TEXT CONTENTS YYYYYYYYYYYYYYYYYYYYYYYYYYYYYYYYYYYY
340 JUST THE INPUT 10 TEXT CONTENTS YYYYYYYYYYYYYYYYYYYYYYYYYYYYYYYYYYYY
341 JUST THE INPUT 11 TEXT CONTENTS YYYYYYYYYYYYYYYYYYYYYYYYYYYYYYYYYYYY
342 JUST THE INPUT 12 TEXT CONTENTS YYYYYYYYYYYYYYYYYYYYYYYYYYYYYYYYYYYY
343 JUST THE INPUT 13 TEXT CONTENTS YYYYYYYYYYYYYYYYYYYYYYYYYYYYYYYYYYYY
344 JUST THE INPUT 14 TEXT CONTENTS YYYYYYYYYYYYYYYYYYYYYYYYYYYYYYYYYYYY
345 INPUT 0 TEXT XXXXXXXXXXXXXXXXXXXXbYYYYYYYYYYYYYYYYYYYYYYYYYYYYYYYYYYY + T
in which XXXXXXXXXXXXXXXXXXXX are 16 characters of the heading and
YYYYYYYYYYYYYYYYYYYYYYYYYYYYYYYYYYY are 32 characters of the input 0 text contents, just the entered
characters are printed, from left to right.
346 INPUT 1 TEXT XXXXXXXXXXXXXXXXXXXXbYYYYYYYYYYYYYYYYYYYYYYYYYYYYYYYYYYY + T
347 INPUT 2 TEXT XXXXXXXXXXXXXXXXXXXXbYYYYYYYYYYYYYYYYYYYYYYYYYYYYYYYYYYY + T
348 INPUT 3 TEXT XXXXXXXXXXXXXXXXXXXXbYYYYYYYYYYYYYYYYYYYYYYYYYYYYYYYYYYY + T
349 INPUT 4 TEXT XXXXXXXXXXXXXXXXXXXXbYYYYYYYYYYYYYYYYYYYYYYYYYYYYYYYYYYY + T
350 INPUT 5 TEXT XXXXXXXXXXXXXXXXXXXXbYYYYYYYYYYYYYYYYYYYYYYYYYYYYYYYYYYY + T
351 INPUT 6 TEXT XXXXXXXXXXXXXXXXXXXXbYYYYYYYYYYYYYYYYYYYYYYYYYYYYYYYYYYY + T
352 INPUT 7 TEXT XXXXXXXXXXXXXXXXXXXXbYYYYYYYYYYYYYYYYYYYYYYYYYYYYYYYYYYY + T
353 INPUT 8 TEXT XXXXXXXXXXXXXXXXXXXXbYYYYYYYYYYYYYYYYYYYYYYYYYYYYYYYYYYY + T
354 INPUT 9 TEXT XXXXXXXXXXXXXXXXXXXXbYYYYYYYYYYYYYYYYYYYYYYYYYYYYYYYYYYY + T
355 INPUT 10 TEXT XXXXXXXXXXXXXXXXXXXXbYYYYYYYYYYYYYYYYYYYYYYYYYYYYYYYYYYY + T
356 INPUT 11 TEXT XXXXXXXXXXXXXXXXXXXXbYYYYYYYYYYYYYYYYYYYYYYYYYYYYYYYYYYY + T
357 INPUT 12 TEXT XXXXXXXXXXXXXXXXXXXXbYYYYYYYYYYYYYYYYYYYYYYYYYYYYYYYYYYY + T
358 INPUT 13 TEXT XXXXXXXXXXXXXXXXXXXXbYYYYYYYYYYYYYYYYYYYYYYYYYYYYYYYYYYY + T
359 INPUT 14 TEXT XXXXXXXXXXXXXXXXXXXXbYYYYYYYYYYYYYYYYYYYYYYYYYYYYYYYYYYY + T
360 INDICATOR DATE DD/MM/YY
361 INDICATOR TIME HH:MM:SS

```

362	INDICATOR DATE TIME	DD/MM/YY b BHH:MM:SS
363	SKIPS FOLLOWING MACRO TERMINATOR	
364	ONLY HEADING OF LINE 1	XXXXXXXXXXXXXXXXXXXXXXXXXXXX + T
365	ONLY HEADING OF LINE 2	XXXXXXXXXXXXXXXXXXXXXXXXXXXX + T
366	ONLY HEADING OF LINE 3	XXXXXXXXXXXXXXXXXXXXXXXXXXXX + T
	in which XXXXXXXXXXXXXXXXXXXXXXX are the 24 characters of the first line of the heading; just the entered characters are printed, from left to right.	
367	JUST GROSS ON 10 DIGITS	XXXXXXXXXXXX
	the field expands from right to left, with many spaces for completing the field length.	
368	JUST NET ON 10 DIGITS	XXXXXXXXXXXX
369	JUST TARE ON 10 DIGITS	XXXXXXXXXXXX
370	ACTIVE SCALE NUMBER	SCALE b NUMBER b X + T
	in which X is the active scale number (0..4)	
371	JUST ACTIVE SCALE NUMBER	X
	in which X is the active scale number (0..4)	
372	SCALE UNIT OF MEASURE	UM + T
373	JUST DATABASE UNIT OF MEASURE	UM
	The field expands from right to left.	
374	TICKET PROGRESSIVE	XXXXXX
	(progressive number that increases at every general total printing)	
	the field expands from right tot left, with many spaces for completing the field length.	
375	STANDARD KD PROTOCOL STRING	
376	AFX PROTOCOL STRING	
	By using blocks 375 and 376 it is possible to print the STANDARD or AFX serial string (see 8.4 TRANSMISSION PROTOCOLS section for the description); the string terminator is the one set in the tErMin "SET TERMINATOR TYPE" step in the SET-UP environment (CR or CRLF or no terminator).	
377	PRINTS TERMINATOR	CR or CRLF or NO TERMINATOR
378	JUST GENERAL TOTAL OF WRONG CYCLES	XXXXXX
	The field expands on 5 digits, from right to left; blank spaces are printed to complete the field.	
379	JUST TOTAL OF CYCLES IN TOLERANCE FOR GENERAL TOTAL	XXXXXX
	The field expands on 5 digits, from right to left.	
380	JUST GENERAL TOTAL OF CYCLES MADE	XXXXXX
381	JUST DATE OF LAST ZEROING OF GENERAL TOTAL	DD/MM/YY
382	JUST GENERAL ERROR TOTAL IN THE DOSAGES WITHIN TOLERANCE	XXXXXXXX
	The field expands on 8 digits, from left to right	
	This field prints the algebraic sum of the difference between the dosed weight and the set target (the error) of each executed dosage activity.	
	The block refers to the active formula.	
383	INTERRUPTED CYCLE ONLY TEXT	bbbb INTERRUPTED b CYCLE + T
384	WEIGHT ERRORS ONLY TEXT	b WEIGHT b OUT OF b TOLERANCE + T WEIGHT b BEYOND b MAX. b TARE + T WEIGHT b BELOW b MIN. b TARE + T bb WEIGHT b OUT b OF b ZERO + T bb UNSTABLE b WEIGHT + T END b OF b MAX b DOSAGE b TIME + T SCALE b OUT b OF b CAPACITY + T TIMER b ALARM + T

385 ACTIVITY END LOADING DOSEbXXXXXXXXUM
 DOSEDbXXXXXXXXUM + T
 UNLOADING UNLOADEDbbXXXXXXXXXXUM + T
 MANUAL DOSAGE DEMXXXXXXXXUM + T
 TIMER ADDXXXXXXXXUMbbdosed:XXXXXX
 PAUSE ADDXXXXXXXXUMbbdosed:XXXXXX

NOTE: For the TIMER and PAUSE activities, the macro is printed only if one has enabled the sum of the eventual dosed weight at the end of these activities together with the dosed total weight, in the **Add.t** and **Add.P** parameters, TECH.MAN.REF.

386 PARTIAL UNLOADING END UNLOADEDbbXXXXXXXXXXUM + T
 387 CYCLES TOTALS TARGETXXXXXXXXXXUM
 DOSEXXXXXXXXXXUM
 OUT OF TOL.XXXXXXXXXXXUM + T

388 CYCLE TOTALS TARGETXXXXXXXXXXUM
 DOSEXXXXXXXXXXUM
 OUT OF TOL.XXXXXXXXXXXUM + T

in which TARGET is the TOTAL CYCLES/CYCLE PROGRAMMED, DOSED the TOTAL CYCLES/CYCLE MADE, OUT OF TOL the TOTAL CYCLES/CYCLE OUT OF CAPACITY; XXXXXXXXXXXX is the weight value on 10 digits including the comma (the field expands from right to left, with many spaces for completing the length of the field); UM indicates the scale's unit of measure..

389 JUST GENERAL TOTAL DOSED OUT OF TOLERANCE XXXXXXXX

The field expands on 8 digits, from right to left; blank spaces are printed to complete the field.

390 JUST GENERAL TOTAL DOSED WITHIN TOLERANCE XXXXXXXX;

The field expands on 8 digits, from right to left; blank spaces are printed to complete the field.

391 JUST DOSED GENERAL TOTAL XXXXXXXX

The field expands on 8 digits, from right to left, blank spaces are printed to complete the field.

392 LAST TOTAL DOSED WEIGHT AND TARE TAREXXXXXXXXXXUM + T
 DOSED CYCLEXXXXXXXXXXUM

393 JUST "OUT OF T. CYCLES" TEXT CYCLES OFF

394 JUST "OK CYCLES" TEXT CYCLES OK

395 JUST "ERROR" TEXT ERROR

396 JUST "OUT OF TOL." TEXT OUT OF TOL.

397 JUST "IN TOLERANCE." TEXT IN TOLERANCE

398 JUST "CYCLES TOTAL" TEXT CYCLES TOTAL

399 JUST "DOSED TOTAL" TEXT DOSED TOTAL

400 JUST "GENERAL TOTAL" TEXT GENERAL TOTAL

401 DATABASE UNIT OF MEASURE UM

402 JUST LAST TOTAL DOSED WEIGHT XXXXXXXX

The field expands from right to left, with many spaces for completing the length of the field

403 LAST TOTAL DOSED WEIGHT DOSED CYCLEXXXXXXXXXXUM

404 CYCLE REPORT CYCLEbREPORTbXX/YY + T

in which XX indicates the number of dosages made, YY indicates the number of programmed cycle repetitions.

405 FORMULA DESCRIPTION FORMULAbXXXXXXXXXXXXXXXXXXXXX + T

in which XXXXXXXXXXXXXXXXXXXX are the 20 description characters of the selected formula; just the entered characters are printed, from right to left.

406 TYPE OF ACTIVITY 0XbMANUAL DOS.bbbb

0XbAUTOMATIC DOS.b

0XbMANUALbWEIGHTb

0XbUNLOADbbbbbbbb

0XbTIMERbbbbbbbb

0XbWAITbbbbbbbb

The text varies depending on the type of activity carried out.

407 ONLY DESCRIPTION OF ACTIVITY XXXXXXXXXXXXXXXXXXXX

408	TARGET	DOSEXXXXXXXXXXUM + T
	in which XXXXXXXXXXX is the weight value on 10 digits including the comma (the field expands from right to left, with many spaces for completing the length of the field); UM indicates the unit of measure of the scale.	
409	ONLY NUMBER OF LAST CYCLE MADE	XXX
	It is the last complete cycle made; the field expands on three digits and also the non significant zeros are printed	
410	JUST FORMULA DESCRIPTION	XXXXXXXXXXXXXXXXXX
411	JUST SELECTED FORMULA TARGET VALUE	XXXXXXXX
	The field expands in 8 digits, from right to left; the target is printed just during the execution of the dosage.	
412	JUST DOSED TOTAL OF SELECTED FORMULA	XXXXXXXX
	The field expands on 8 digits, from right to left; blank spaces are printed to complete the field.	
413	JUST OUT OF TOLERANCE DOSED TOTAL OF SELECTED FORMULA	XXXXXXXX
	The field expands in 8 digits, from right to left; the target is printed just during the execution of the dosage.	
414	JUST ERROR TOTAL IN DOSAGES WITHIN TOLERANCE FOR FORMULA TOTAL	XXXXXXXX
	The field expands on 8 digits from right to left; This field prints the algebraic sum of the difference between the dosed weight and the set target (the error) of each executed dosage activity. The block refers to the active formula.	
415	JUST TOTAL OF CYCLES MADE FOR SELECTED FORMULA	XXXXX
416	JUST TOTAL OF WRONG CYCLES FOR SELECTED FORMULA	XXXXX
417	JUST DATE OF LAST ZEROING OF FORMULA TOTAL	DD/MM/YY
418	JUST NUMBER OF REPETITIONS OF SELECTED FORMULA	XXX
	The field expands on three digits, from right to left; also the non significant zeros are printed.	
419	JUST TOTAL OF CYCLES WITHIN TOLERANCE FOR SELECTED FORMULA	XXXXX
420	JUST TOTAL DOSED WITHIN TOLERANCE FOR SELECTED FORMULA	XXXXXXXX
	The field expands on 8 digits, from right to left; blank spaces are printed to complete the field.	
421	JUST CURRENT CYCLE NUMBER	XXX
	It is the cycle in execution; the field expands on three digits and also the non significant zeros are printed.	
422	JUST TYPE OF ACTIVITY DESCRIPTION	MAN. DOSAGE or AUTOMATIC DOS. or MANUAL WEIGHT or UNLOADING
	The text varies depending on the type of activity made.	
423	ONLY PROGRESSIVE OF EXECUTED ACTIVITIES	0X
	In which X can take on two different values depending on the type of activity made: 1 automatic or manual dosage, 2 for unloading.	
424	JUST SCALE UNIT OF MEASURE IN USE	UM
	The field expands from right to left.	
425	JUST NUMBER OF SCALE IN USE	X
426	ONLY DOSED WEIGHT ERROR FOR SELECTED FORMULA	XXXXXXXX
	The block expands from right to left; just the significant digits are printed.	
427	ONLY ACTIVITY END WEIGHT	XXXXXXXX
	The field expands on 8 digits, from right to left; blank spaces are printed to complete the field.	

NOTE: For the TIMER and PAUSE activities, the macro is printed only if one has enabled the sum of the eventual dosed weight at the end of these activities together with the dosed total weight, in the **Add.t** and **Add.P** parameters, TECH.MAN.REF.

428	ONLY YEAR IN YY FORMAT	YY
429	ONLY MONTH IN MM FORMAT	MM
430	ONLY DAY IN DD FORMAT	DD
431	ONLY HOUR IN HH FORMAT	HH
432	ONLY THE MINUTES IN MM FORMAT	MM
433	ONLY CONDITIONED TARE TEXT	XXXXXX
	XXXXXX becomes TARE bb when the tare is equal to 0 or semiautomatic, PT bbbb with manual tare.	

434	ONLY CONDITIONED PT TEXT		XX
	XX becomes bb with tare equal to 0 or semiautomatic, PT with manual tare.		
435	TIMER ACTIVITY TIMES	TARGET bbbbbbbbb XXXXX.Xs ELAPSED bbbbbbbbb XXXXX.Xs + T	
	In witch TARGET is the programmed time, DELAY is the elapsed time and "s" is the unit of measure (seconds)		
436	PRINTS 3 CRLF		
437	ACTIVE SCALE NUMBER		SX + T
	in which X is the active scale number (0..4)		
438	JUST CURRENT NET WEIGHT VALUE	XXXXXXXXXX	
439	JUST CURRENT GROSS WEIGHT VALUE	XXXXXXXXXX	
440	JUST CURRENT TARE WEIGHT VALUE	XXXXXXXXXX	
	in which XXXXXXXXXX is the value of the weight on the weight system, in 10 digits including the comma; the field expands from right to left.		
441	INDICATOR TIME		HMMSS
442	INDICATOR DATE		YYMMDD
443	JUST "GROSS" TEXT		GROSS b
444	JUST "NET" TEXT		NET bbb
445	JUST "TARE" TEXT		TARE bb
446	ENABLES PAPER PRESENT SENSOR FOR TM295		
447	RELEASES PAPER FOR TM295		
448	EMISSION AND PAPER RELEASE FOR TM295		
449	LARGE FONT FOR TM295 (2,5x6 mm - LxA)		
450	MEDIUM SIZE FONT FOR TM295 (1,5x6 mm - LxA)		
451	SMALL FONT FOR TM295 (1,5x3 mm - LxA)		
452	MEDIUM SIZE FONT FOR LX300		
453	LARGE FONT FOR LX300		
454	SMALL FONT FOR LX300		
455	LARGE FONT FOR DP190 (3x5 mm - LxA)		
456	MEDIUM SIZE FONT FOR DP190 (1,5x5 mm - LxA)		
457	SMALL FONT FOR DP190 (1,5x2,5 mm - LxA)		
458	STARTS BARCODE 39 FOR THERMAL DP190		
459	ENABLES TIME - OUT FOR TM295		
460	ONLY LAST DOSED WEIGHT		XXXXXXXX
	It is the last net weight actually dosed, in which XXXXXXX is the weight value on 8 digits including the comma (the field expands from right to left, with many spaces for completing the length of the field).		
461	FORMULA TARGET	TARGET bbbbbbbbb XXXXXXXXXUM + T	
	in which XXXXXXXX is the weight value on 8 digits including the comma (the field expands from right to left, with many spaces for completing the length of the field); UM indicates the unit of measure of the archive.		
462	LAST DOSED WEIGHT	DOSED WEIGHT bbbbbbbbb XXXXXXXXXUM + T	
	It is the last net weight actually dosed, in which XXXXXXX is the weight value on 8 digits including the comma (the field expands from right to left, with many spaces for completing the length of the field); UM indicates the unit of measure of the archive		
463	DOSED WEIGHT	DOSED WEIGHT bbbbbbbbb XXXXXXXXXUM + T	
	in which XXXXXXXX is the weight value on 8 digits including the comma (the field expands from right to left, with many spaces for completing the length of the field); UM indicates the unit of measure of the scale.		
464	JUST "CYCLE REPORT" TEXT		CYCLE REPORT
465	JUST "CYCLES REPORT" TEXT		CYCLES REPORT
466	JUST "START PRODUCTION" TEXT		START PRODUCTION
467	JUST "END PRODUCTION" TEXT		END PRODUCTION
468	FIRST PRODUCTION TARGET CONTENT	YYY bb XXXXXXXXXXXXXXXXXXXXXXXXXXXXXXXXXXXXAAAUUM + T	
	In which YYY is formula number, XXXXXXXXXXXXXXXXXXXX is 16 characters of formula description, AAAAAAAA is the weight value on 8 digits including the comma (the field expands from right to left, with many spaces for completing the length of the field); UM indicates the unit of measure of the scale.		
469	SECOND PRODUCTION TARGET CONTENT	YYY bb XXXXXXXXXXXXXXXXXXXXXXXXXXXXXXXXXXXXAAAUUM + T	
470	THIRD PRODUCTION TARGET CONTENT	YYY bb XXXXXXXXXXXXXXXXXXXXXXXXXXXXXXXXXXXXAAAUUM + T	

471 FOURTH PRODUCTION TARGET CONTENT YYY**bb**XXXXXXXXXXXXXXXXXXXXXXXXXXXXXXXXXUM + T
 472 FIRST PRODUCTION DOSED CONTENT YYY**bb**XXXXXXXXXXXXXXXXXXXXXXXXXXXXXXXXXUM + T
 In which YYY is formula number, XXXXXXXXXXXXXXXXXXXX is 16 characters of formula description, BBBBBBBB is the dosed material value on 8 digits including the comma (the field expands from right to left, with many spaces for completing the length of the field); UM indicates the unit of measure of the scale.

473 SECOND PRODUCTION DOSED CONTENT YYY**bb**XXXXXXXXXXXXXXXXXXXXXXXXXXXXXXXXXUM + T
 474 THIRD PRODUCTION DOSED CONTENT YYY**bb**XXXXXXXXXXXXXXXXXXXXXXXXXXXXXXXXXUM + T
 475 FOURTH PRODUCTION DOSED CONTENT YYY**bb**XXXXXXXXXXXXXXXXXXXXXXXXXXXXXXXXXUM + T
 476 TOTAL PRODUCTION TARGET TOTAL**bbbbbbbb**XXXXXXXXXUM + T
 in which XXXXXXXX is the weight value on 8 digits including the comma (the field expands from right to left, with many spaces for completing the length of the field); UM indicates the unit of measure of the scale.

477 TOTAL PRODUCTION DOSED WEIGHT DOSED**bbbbbbbb**XXXXXXXXXUM + T
 XXXXXXXX is the dosed material value on 8 digits including the comma (the field expands from right to left, with many spaces for completing the length of the field); UM indicates the unit of measure of the scale.

478 THE NUMBER OF PRODUCTION FORMULA PRODUCTION FORMULA:**b**X + T
 In which X is active production formula number.

479 JUST FIRST PRODUCTION FORMULA NUMBER XXX
 In which XXX is formula number.

480 JUST FIRST PRODUCTION FORMULA DESCRIPTION XXXXXXXXXXXXXXXXXXXX
 In which XXXXXXXXXXXXXXXXXXXX is 16 characters of formula description.

481 JUST FIRST PRODUCTION TARGET WITH UNIT OF MEASURE XXXXXXXXUM
 in which XXXXXXXX is the weight value on 8 digits including the comma (the field expands from right to left, with many spaces for completing the length of the field); UM indicates the unit of measure of the scale.

482 JUST FIRST PRODUCTION DOSED WEIGHT WITH UNIT OF MEASURE XXXXXXXXUM
 in which XXXXXXXX is the dosed material value on 8 digits including the comma (the field expands from right to left, with many spaces for completing the length of the field); UM indicates the unit of measure of the scale.

483 JUST SECOND PRODUCTION FORMULA NUMBER XXX
 In which XXX is formula number.

484 JUST SECOND PRODUCTION FORMULA DESCRIPTION XXXXXXXXXXXXXXXXXXXX
 In which XXXXXXXXXXXXXXXXXXXX is 16 characters of formula description.

485 JUST SECOND PRODUCTION TARGET WITH UNIT OF MEASURE XXXXXXXXUM
 in which XXXXXXXX is the weight value on 8 digits including the comma (the field expands from right to left, with many spaces for completing the length of the field); UM indicates the unit of measure of the scale.

486 JUST SECOND PRODUCTION DOSED WEIGHT WITH UNIT OF MEASURE XXXXXXXXUM
 in which XXXXXXXX is the dosed material value on 8 digits including the comma (the field expands from right to left, with many spaces for completing the length of the field); UM indicates the unit of measure of the scale.

487 JUST THIRD PRODUCTION FORMULA NUMBER XXX
 In which XXX is formula number.

488 JUST THIRD PRODUCTION FORMULA DESCRIPTION XXXXXXXXXXXXXXXXXXXX
 In which XXXXXXXXXXXXXXXXXXXX is 16 characters of formula description.

489 JUST THIRD PRODUCTION TARGET WITH UNIT OF MEASURE XXXXXXXXUM
 in which XXXXXXXX is the weight value on 8 digits including the comma (the field expands from right to left, with many spaces for completing the length of the field); UM indicates the unit of measure of the scale.

490 JUST THIRD PRODUCTION DOSED WEIGHT WITH UNIT OF MEASURE XXXXXXXXUM
 in which XXXXXXXX is the dosed material value on 8 digits including the comma (the field expands from right to left, with many spaces for completing the length of the field); UM indicates the unit of measure of the scale.

491 JUST FOURTH PRODUCTION FORMULA NUMBER XXX
 In which XXX is formula number.

492 JUST FOURTH PRODUCTION FORMULA DESCRIPTION XXXXXXXXXXXXXXXXXXXX
 In which XXXXXXXXXXXXXXXXXXXX is 16 characters of formula description.

493 JUST FOURTH PRODUCTION TARGET WITH UNIT OF MEASURE XXXXXXXXUM
 in which XXXXXXXX is the weight value on 8 digits including the comma (the field expands from right to left, with many spaces for completing the length of the field); UM indicates the unit of measure of the scale.

494 JUST FOURTH PRODUCTION DOSED WEIGHT WITH UNIT OF MEASURE XXXXXXXXUM
 in which XXXXXXXX is the dosed material value on 8 digits including the comma (the field expands from right to left, with many spaces for completing the length of the field); UM indicates the unit of measure of the scale.

495 JUST THE OPERATION RESULT
 496 JUST 1 INSERED DATA
 497 JUST 2 INSERED DATA
 498 JUST OPERATION TYPE
 499 PRINT DGTQF REMOTE ADDRESS
 500 JUST 2 FORMULA DESCRIPTION
 501 PRINT ONLY SET/REAL TARGET FORMULA
 502 PRINT HEADER AND SET/REAL TARGET FORMULA

10.4 BLOCKS WITH PARAMETERS

When entering the following blocks manually in a print ticket, these require that an additional numeric value be entered (specified in detail in the block's description) in order to define the print ticket which one wants to obtain.

EXAMPLE

Entry of the 600 "PRINT n TERMINATORS" block:

- Enter the 600 block in a ticket and confirm with **ENTER**.
- The indicator does not pass by the block present in the following line, but shows "000".
- Enter a value between 001 and 050; for values outside this interval the indicator shows "-Error-", restoring the block before entering the block 600.
- By entering a valid value, the block will print a number of terminators equal to the one previously entered.

600	PRINTS n TERMINATORS	Values valid from 001 to 050
601	PRINTS n LF CHARACTERS	Values valid from 001 to 050
602	PRINTS n TAB CHARACTERS	Values valid from 001 to 050
603	PRINTS n SPACE CHARACTERS	Values valid from 001 to 050
604	PRINTS n " _ " CHARACTERS	Values valid from 001 to 050
605	LEFT MARGIN FOR LX300	Values valid from 001 to 255
606	NET WEIGHT ON X DIGITS	Values valid in the nXX format
607	GROSS WEIGHT ON X DIGITS	Values valid in the nXX format
608	TARE WEIGHT ON X DIGITS	Values valid in the nXX format

in which n can be:

- | | |
|---|--|
| 0 | Value with decimal point and spaces |
| 1 | Value with decimal point and zeros in the place of spaces |
| 2 | Value without decimal point and zeros in the place of spaces |

XX is the field length (maximum enterable value is 20); if the weight value is greater than the number of entered digits, the complete value is printed anyways.

#####

EXAMPLE

With a weight value of 100.01, if one wants a length of 10 characters, in the three cases one will have:

<u>Parameter</u>	<u>Result</u>
010	100.01
110	0000100.01
210	0000010001

#####

609	SET VALUE IN THE ACCUMULATOR	Values valid in the XXX format
	In which XXX can be:	
	000 Net weight.	
	001 Gross weight.	
	002 Tare weight.	
610	SETS VALUE DECIMALS IN THE ACCUMULATOR	Values valid in the XXX format

in which **XXX** can be:

000 No decimal
 001 1 decimal
 002 2 decimals
 003 3 decimals
 004 4 decimals

NOTE: if no decimals are set, the ones of the scale are used.

611 SETS CONVERSION UNIT OF MEASURE OF THE ACCUMULATOR VALUE

Values valid in the **XXX** format in which **XXX** can be:

000 g
 001 kg
 002 t
 003 lb

Then if the weight is expressed in grams and one uses the [611; 001] macro, the value will be converted into kg.

NOTE: if no unit of measure has been set, the one of the scale is used.

612 PRINTS VALUE LOADED IN THE ACCUMULATOR

Values valid in the **nXX** format

In which **n** can be:

0 Value with decimal point and spaces
 1 Value with decimal point and zeros in the place of spaces
 2 Value without decimal point and zeros in the place of spaces

XX is the length of the field (maximum enterable value is 20); if the weight value is greater than the number of entered digits, the complete value is printed anyways.

#####

EXAMPLE

The scale is with three decimals and the unit of measure is the kg; one wants to print the net weight with two decimals converted in pounds, expressed in 7 digits without decimal points, with non significant zeros filling in the eventual spaces present.

One should set the following macros:

...
 609 >>> enter parameter 000
 610 >>> enter parameter 002
 611 >>> enter parameter 003
 612 >>> enter parameter 207

....

If the net weight of the scale corresponds to 2,480 kg, the printed value will be **0000547**

#####

613 SET OUTPUT FUNCTIONING

Values valid in the **nXX** format

In which **n** is the status:

0 OFF
 1 or 2 ON

XX is the number of the output to be enabled, from 00 to 15.

If one needs to manage various printers using the available outputs (connecting the transmission of the printer port on the common of the outputs), follow the example in macro 624

614 EAN/UCC CHECKDIGIT ON X PREVIOUS DIGITS

Values valid in the **XX** format

615 CONVERSION OF THE "." (POINT) CHARACTER IN THE "," (COMMA) CHARACTER
 IN THE PREVIOUS X DIGITS

Values valid in the **XX** format

NOTE: if one uses the 614 and 615 blocks, one should enter the block 314 "FORCES PRINTING" before the

blocks that need to be converted.**EXAMPLE**

314 FORCES PRINTING
 307 PRINTS NET WEIGHT
 615 >>> parameter 20 CONVERSION OF THE "." (POINT) CHARACTER IN THE "," (COMMA)

617 The net weight value will be printed with the comma instead of with the point
 PRINT DIRECTION FOR MASTER / SLAVE SYSTEM Valid values **000, 001, 002**
 000 → Prints only on the SLAVE.
 001 → Prints only on the MASTER.
 002 → Prints only on the indicator which is being used.

620 CLEARING INPUT TEXT CONTENTS Values valid in the **nXX** format
 This macro allows to print an input text content or to clear the contents of the input text content.

n can be:

0 to print
 1 to clear.

XX is the number of the input text (XX = 01 to clear the text contents of input 0, XX=15 to clear the contents of the text of input 14, XX=00 to clear all the contents of the input texts).

621 SETTING THE ALIGNMENT AND NUMBER OF FORMATTING CHARACTERS Values valid in the **nXX** format
 This macro, followed by 620, allows to align to the right or to the left, the contents of the following macro in regards to the defined number of characters.

n can be:

0 to set the alignment to the right
 1 to set the alignment to the left

XX is the number of formatting characters.

See the example in the 620 macro.

622 SETTING THE FILLING CHARACTER OF THE FOLLOWING MACRO Values valid in the **XXX** format.
 This macro allows to set the filling character of the following macro.

XXX corresponds to the ASCII decimal character (from 001 to 255).

#####

EXAMPLE

If one wants to print on the right the contents of the 437 macro (NUMBER OF ACTIVE SCALE) one puts the "-" character (ASCII decimal 045) as filling on the left.

The macro contains 17 characters; therefore if the print line is 24 one should set the following macros:

...
 619 >>> enter parameter 024
 620 >>> enter parameter 045
 437

....
 #####

- 623 CONFIRMATION "WAIT" FROM PC OR BY PRESSING OF **C** KEY Values valid in the **XXX** format
 This macro allows to block the indicator and view the message "WAIT" on the display, after having forced the printing of the previous macros, and waiting for the character confirming that the reception has been made by the PC. In any case it's possible to unlock the indicator by pressing the **C** key.
 Once unlocked, the indicator will print the eventual following macros.

XXX corresponds to the ASCII decimal character to be received in order to unlock the indicator (from 001 to 255, or 000 in case one wants to wait for the "PCOK" command).

NOTE: It's possible to enter more than one confirmation "wait" in the same print format.

#####

EXAMPLE

One wants to lock the indicator after printing a series of data; then one waits for the "-" confirmation character (ASCII decimal 045) and, once received, transmit other data.

One should set the following macros:

```
...
301
302
303
616 >>> enter parameter 045      Setting the wait of the "-" character (ASCII decimal 045)
304
305
306
...
#####
```

- 624 SETTING THE THRESHOLD OF PRINT START OR THE NUMBER OF CHARACTERS TO BE PRINTED FOR THE INPUT TEXT CONTENTS Values valid in the **nXX** format
 This macro allows to define which part of the contents of an input text which is to be printed in the 621 macro.

n can be:

- 0 for setting the threshold beginning;
- 1 for setting the characters to be printed.

XX is the threshold beginning if **n** = 0 or the characters to be printed if **n** = 1.

See the example in the 618 macro.

- 626 FORCES PRINTOUT AND TIME WAIT Values valid in the **XXX** format
 Besides the force printout function it also waits for a period of time.

XXX Wait time (up to 200dsec); for example "001" is equal to 0,1 seconds; "010" equals to 1 second.

EXAMPLE

With the need to manage various printers through the available outputs (by connecting the transmission of the printer port on the common of the outputs), as follows:

PRINTING OF THE NET WEIGHT ON OUTPUT 1, GROSS ON OUTPUT 2, TARE ON OUTPUT 3.

One should set the following macros:

```
...
613 >>> enter parameter 100 ((OUT 1 ON)
613 >>> enter parameter 001 ((OUT 2 OFF)
613 >>> enter parameter 002 ((OUT 3 OFF)
```

```

624 >>> enter parameter 001 (0,1 seconds)
301 (Net weight)
624 >>> enter parameter 001 (0,1 seconds)
613 >>> enter parameter 000 (OUT 1 OFF)
613 >>> enter parameter 101 (OUT 2 ON)
613 >>> enter parameter 002 (OUT 3 OFF)
624 >>> enter parameter 001 (0,1 seconds)
302 (Gross weight)
624 >>> enter parameter 001 (0,1 seconds)
613 >>> enter parameter 000 (OUT 1 OFF)
613 >>> enter parameter 001 (OUT 2 OFF)
613 >>> enter parameter 102 (OUT 3 ON)
624 >>> enter parameter 001 (0,1 seconds)
303 (Tare weight)
624 >>> enter parameter 001 (0,1 seconds)

```

...

627 QUEUE PRINTING FORMAT

Values valid in the **XXX** format

This macro allows to queue one printout format and print this one at the end of the format.

XXX is the number of printout format that will be printed at the end of the format, from 0 to 29 (**0 = Prn.F.1** , **29 = Prn.F.30**)

#####

EXAMPLE

One wants to print the GROSS, TARE and NET values and, at the end, the headers (**Prn.F.2**)

One should set the following macros:

...

```
625>>> enter parameter 001
```

```
307
```

```
308
```

```
309
```

...

#####

- 628 SELECTION OF FROZEN OR IMMEDIATE VALUE Values valid in the **XXX** format
This macro allows to select the type of value of the following macros:

NET:

301

303 (TARE= GROSS – NET)

606

609

GROSS:

302

303 (TARE= **GROSS** – NET)

607

609

TARE:

608

609

Values valid in the **XXX** format in which **XXX** can be:

000 frozen

001 immediate

NOTE: this macro operates in all the printout format.

- 637 BUFFER REDIRECTION Valid values in the format **XXX**

Where **XXX** can be :

-001 inserted into the buffer redirect all the data that follow the macro and prints them

-002 inserted into the buffer redirect all data following the macro (without printing)

-003 print the data buffer of redirections

-004 deleted all data in the buffer

- 638 PRINTS ACTIVITY DESCRIPTION Values valid in the **XXX** format
The macro allows to print activity description after the cycle dosage is terminated.

XXX is the activity number in the formula (for example, if **XXX** is set on 000, it corresponds with first activity in the formula).

- 639 PRINTS ACTIVITY TYPE Values valid in the **XXX** format
The macro allows to print activity type after the cycle dosage is terminated.

XXX is the activity number in the formula (for example, if **XXX** is set on 000, it corresponds with first activity in the formula).

- 640 PRINTS ACTIVITY NUMBER Values valid in the **XXX** format
The macro allows to print activity number after the cycle dosage is terminated.

XXX is the activity number in the formula (for example, if **XXX** is set on 000, it corresponds with first activity in the formula).

- 641 PRINTS DOSED WEIGHT OF THE ACTIVITY Values valid in the **XXX** format
The macro allows to print dosed weight of the activity after the cycle dosage is terminated.

XXX is the activity number in the formula (for example, if **XXX** is set on 000, it corresponds with first activity in the formula).

- 642 PRINTS TARGET OF THE ACTIVITY Values valid in the **XXX** format
The macro allows to print target of the activity after the cycle dosage is terminated.
XXX is the activity number in the formula (for example, if XXX is set on 000, it corresponds with first activity in the formula).
- 643 PRINTS DOSED WEIGHT OF THE ACTIVITY Values valid in the **XXX** format
The macro allows to print dosed weight of the activity after the cycle dosage is terminated.
The decimal of the dosed weight depends on the one of the calibration.
XXX is the activity number in the formula (for example, if XXX is set on 000, it corresponds with first activity in the formula).
- 644 PRINTS TARGET OF THE ACTIVITY Values valid in the **XXX** format
The macro allows to print target of the activity after the cycle dosage is terminated.
The decimal of the target depends on the one of the calibration.
XXX is the activity number in the formula (for example, if XXX is set on 000, it corresponds with first activity in the formula).
- 645 PRINTS SCALE NUMBER FOR THE ACTIVITY Values valid in the **XXX** format
The macro allows to print scale number on which the activity executes after the cycle dosage is terminated.
XXX is the activity number in the formula (for example, if XXX is set on 000, it corresponds with first activity in the formula).
- 646 PRINTS THE UNIT OF MEASURE OF THE ACTIVITY Values valid in the **XXX** format
The macro allows to the unit of the measure of the activity after the cycle dosage is terminated.
XXX is the activity number in the formula (for example, if XXX is set on 000, it corresponds with first activity in the formula).

11. ELECTRICAL CONNECTION SCHEMES

11.1 CPWE BACK PANEL

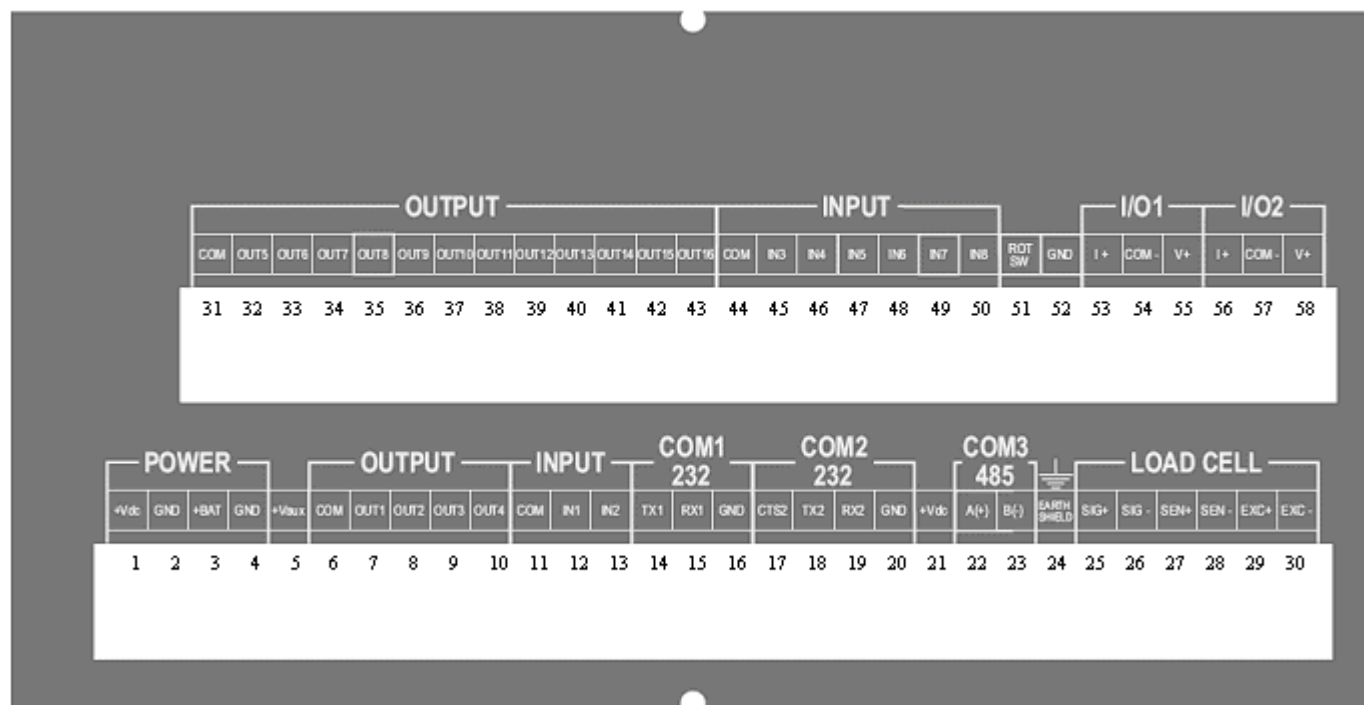

11.2 MOTHER BOARD

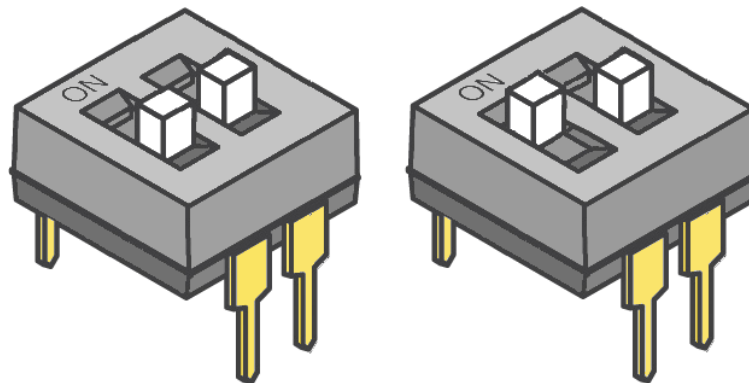
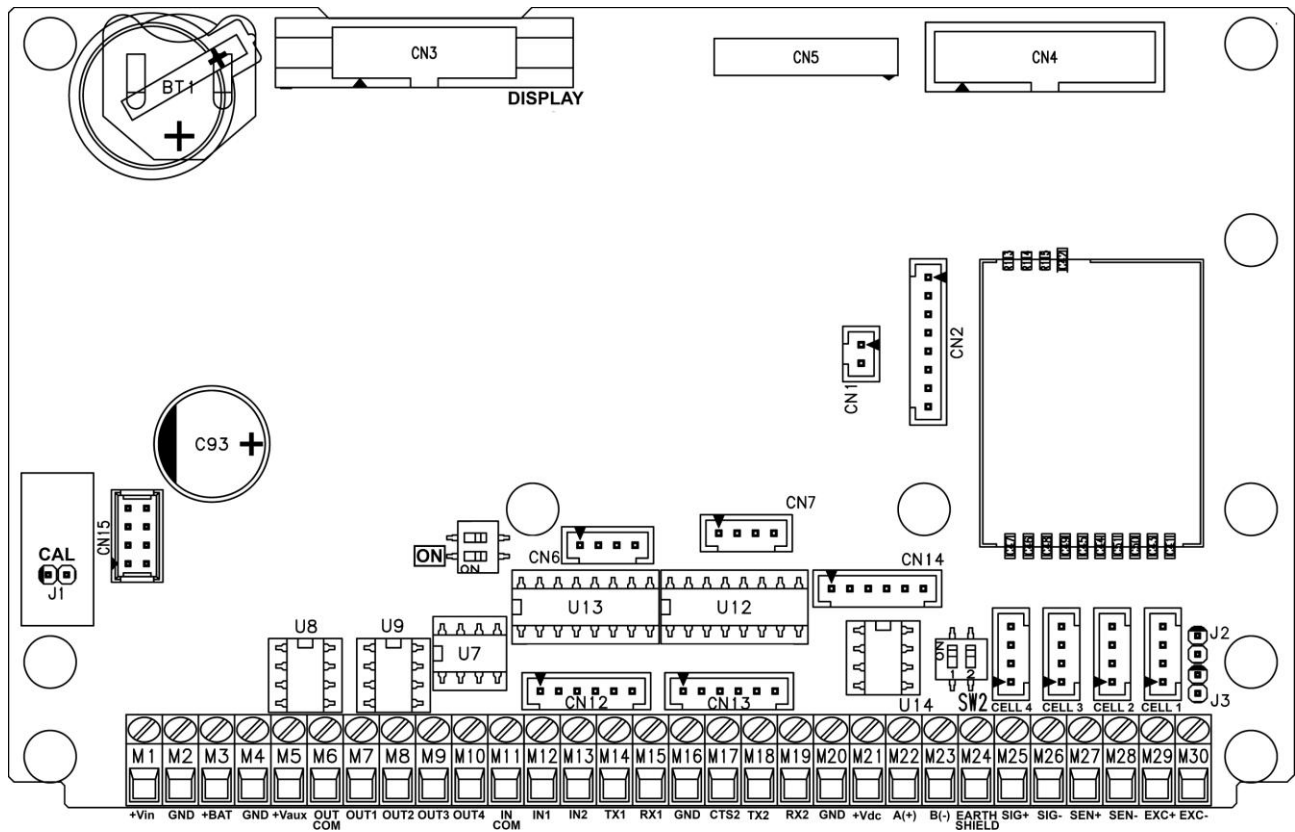

There aren't differences between two switches, doesn't matter which is "ON", is enough activate only one

ON SW:

- If closed, one can automatically turn on the instrument, as soon as the power voltage is supplied, one must also turn off the instrument by removing the mains voltage.
- If open, one can turn the instrument on and off by just pressing the ON key.

J2, J3 (SENSE): if closed, REFERENCE + and POWER SUPPLY +, REFERENCE - and POWER SUPPLY - are jumpered on the board

J1: if opened it enables the access to the metrological parameters, when configuring.

SERIAL PORTS (refer to section 5)

COM 1	COM 2	COM 3
Connector AMP CN12: serial 232 Terminals 14-15-16: serial 232	Connector AMP CN13: serial 232 Terminals 16-17-18-19: serial 232	Connector AMP CN14: serial 232 Terminals 22-23: serial 485 (U14)

IMPORTANT:

In the case of RS485 connection, read carefully and apply what is described in chapter 5.1.

POWER SUPPLY

6 Vdc BATTERY POWER SUPPLY	+Vdc POWER SUPPLY	V-AUX AUXILIARY POWER SUPPLY	+Vdc (OUT) POWER SUPPLY
4 GND (0 Vdc) 3 +BAT (+ 6 Vdc)	2 GND (0 V) 1 +Vdc (+12 Vdc, 8 ÷ 36 Vdc with I/O expansion board connected)	4 GND (0 V) 5 +Vaux (5,3 –8 Vdc 400 mA max)	20 GND (0 V) 21 +Vdc (+12V only if connected to the power supply)

CELL LOAD RECEIVER (terminal board connection)

25	SIG+	SIGNAL +
26	SIG-	SIGNAL -
27	SENS+	SENSE +
28	SENS-	SENSE -
29	EXC+	EXCITATION +
30	EXC-	EXCITATION -

INPUTS (OPTOISOLATOR PHOTOCOUPLEDERS)

Power supply: 12 Vdc ÷ 24 Vdc max 20 mA.

PHOTOMOSFET OUTPUTS

Maximum power: 48 Vac or 60 Vdc, 150 mA max., 10 ohm max

!! IMPORTANT!!

The optoisolation of the inputs and outputs is obtained by powering the common of the outputs and/or of the inputs by using a voltage outside the instrument.

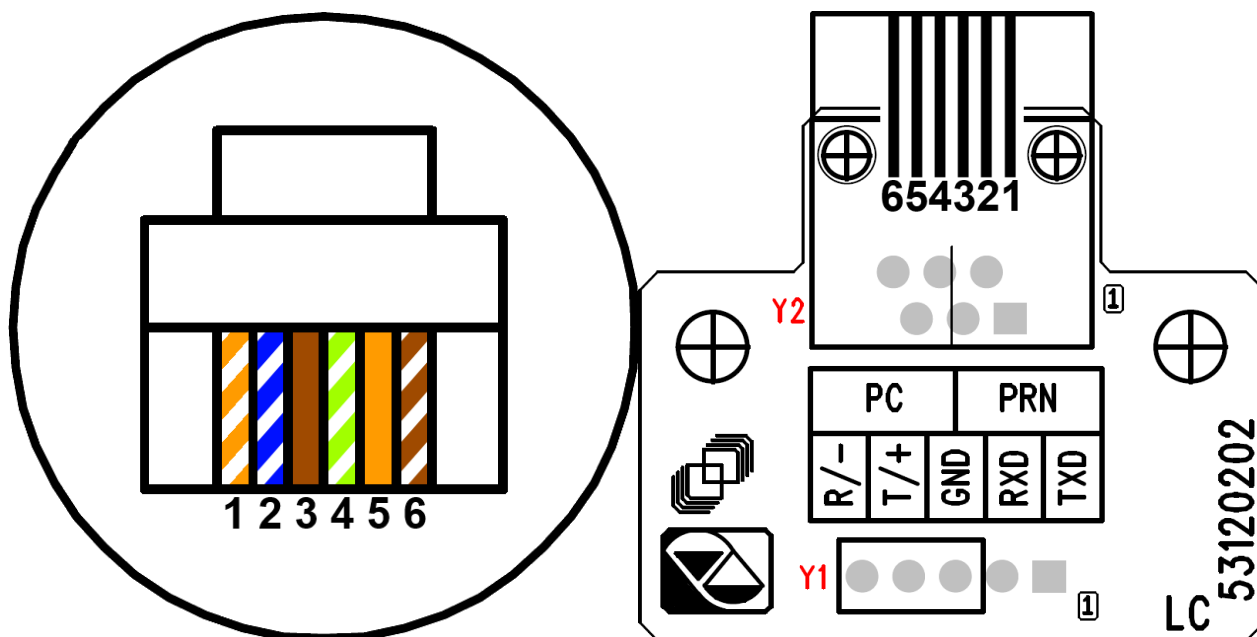
RS232 SERIAL PORT (RJ45 CONNECTOR) (*)**PLUG6 CONNECTIONS:**

Y2	PLUG6	DB9	COLOR		MEANING
1	1		ORANGE	WHITE	
2	2	3	BLUE	WHITE	RX
3	3		BROWN		
4	4	5	GREEN	WHITE	GND
5	5	2	ORANGE		TX
6	6		BROWN	WHITE	

(*) May be present depending on the model.

!! IMPORTANT !!

Use 6-pin RJ12 connector, because the 8-pin connector doesn't fit into the hole of the weight indicator.

11.3 I/O EXPANSION BOARD (fitted with 3590EXT in IO version or CPWE)

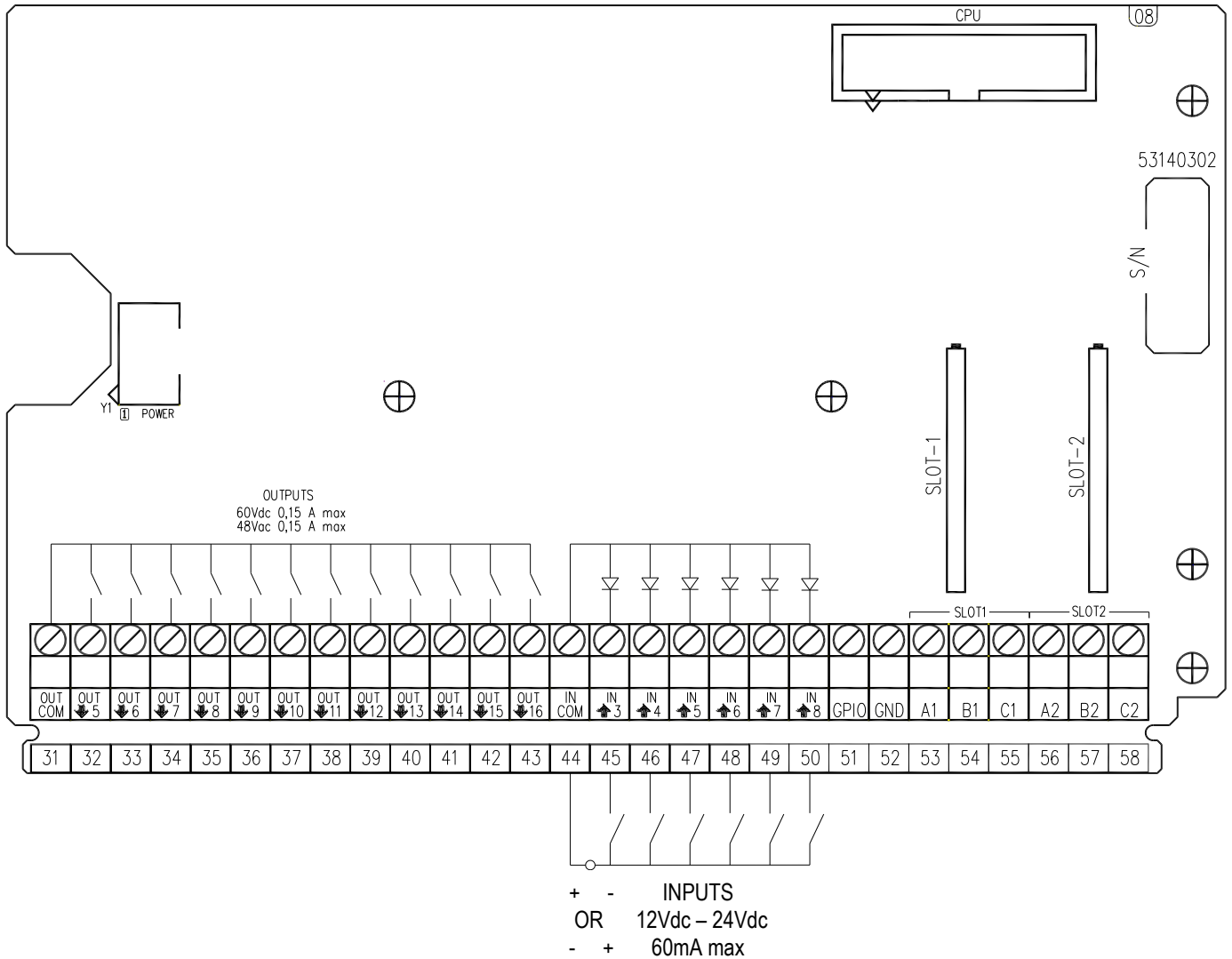

ANALOGUE OUTPUT

I/O1 (SLOT 1):		I/O2 (SLOT 2):	
53	I+ (A1) + 20 mA	56	I+ (A2) + 20 mA
54	COM- (B1) 0 mA / V	57	COM- (B2) 0 mA / V
55	V+ (C1) + 10 V	58	V+ (C2) + 10 V

Note: the maximum resistance applicable on the output current is 350 Ohm and the minimum resistance applicable on the output voltage is 10 kohm.

INPUTS (OPTOISOLATOR PHOTOCOUPLEDERS)

Power supply: 12 Vdc ÷ 24 Vdc max 20 mA.

PHOTOMOSFET OUTPUTS

Maximum power: 48 Vac or 60 Vdc, 150 mA max., 10 ohm max

!! IMPORTANT!!

The optoisolation of the inputs and outputs is obtained by powering the common of the outputs and/or of the inputs by using a voltage outside the instrument.

11.4 INTEGRATED CIRCUITS INSTALLATION

It is necessary follow this procedure to install Input, Output and RS485 integrated circuits:

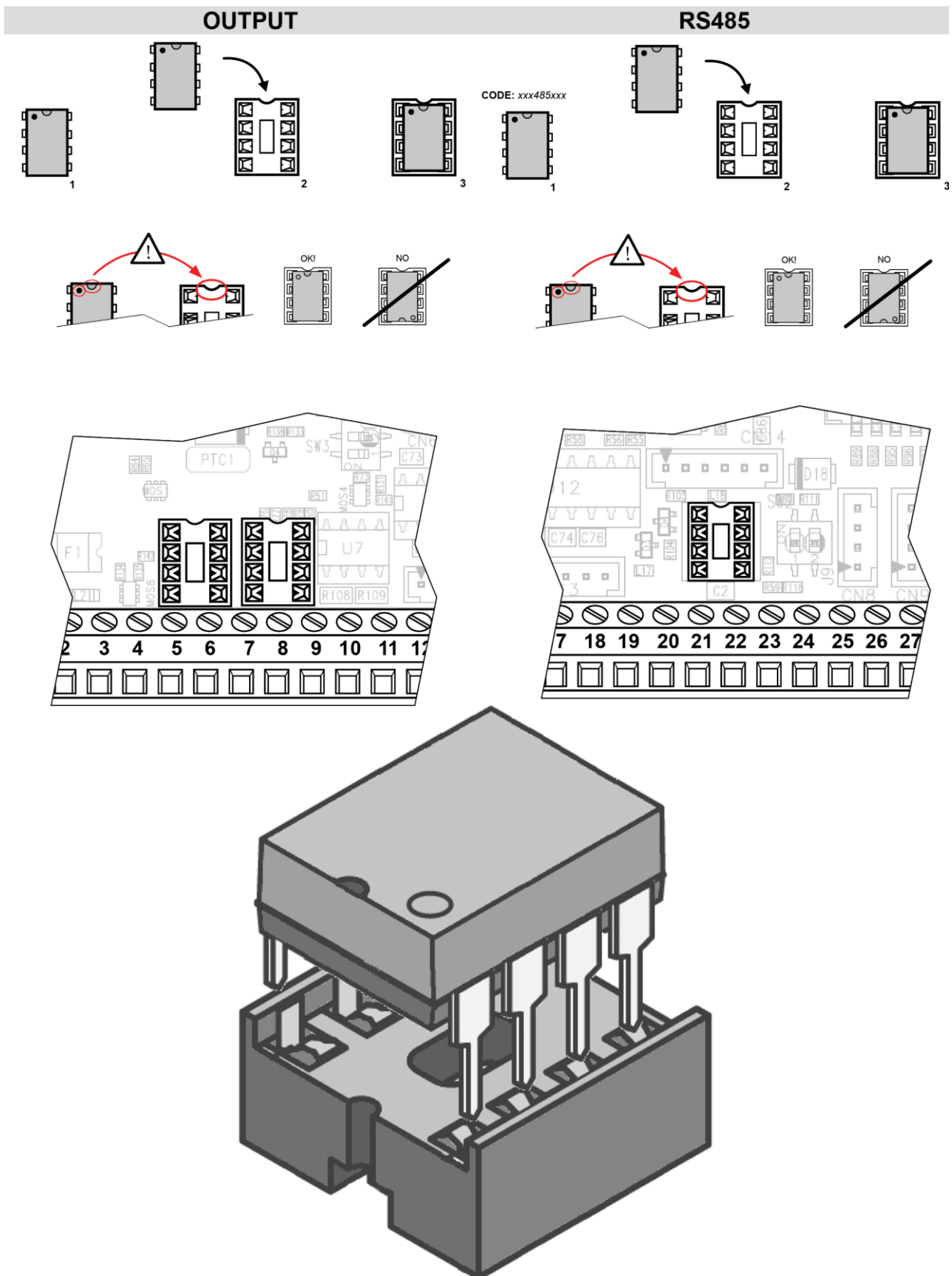

INPUT

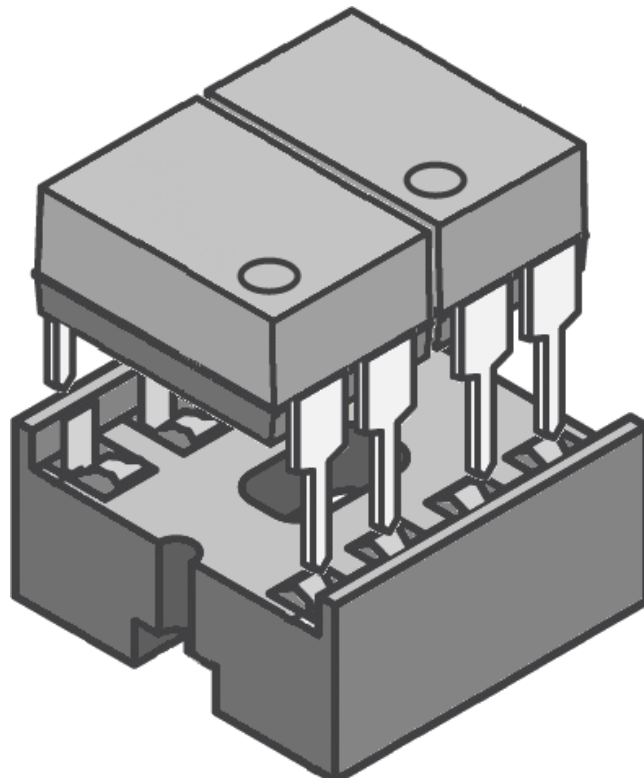
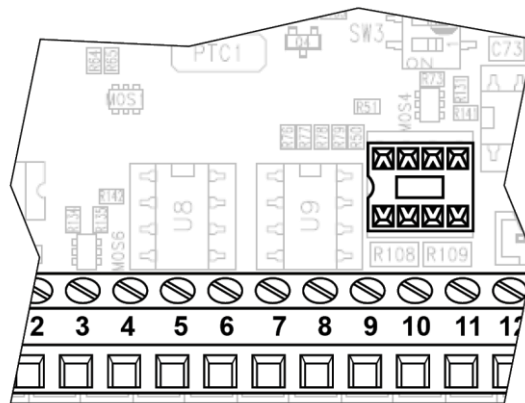
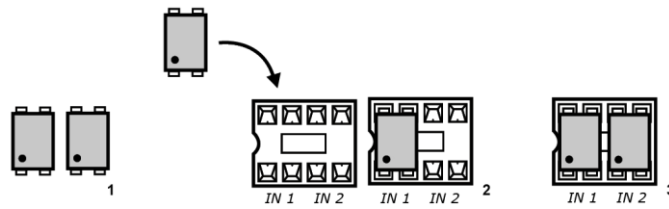

11.5 DISPLAY BOARD

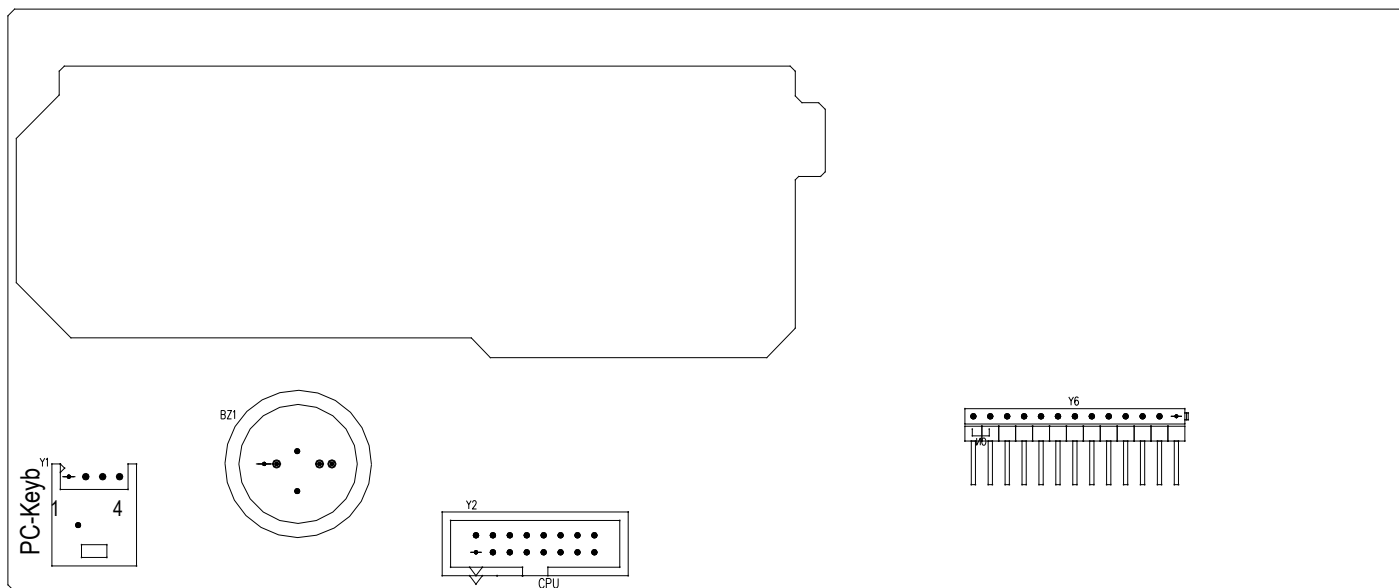

PC-Keyb – PC KEYBOARD CONNECTOR

Keyboard emulation input, usable for the connection of the instrument to the PC keyboard or the badge/bar code reader.

PC-KEYB		PS/2
1	+5V	4
2	GND	3
3	DATA	1
4	CLK	5

11.6 LOAD CELL CONNECTOR CIRCUIT DIAGRAM

7 PIN FEMALE CONNECTOR

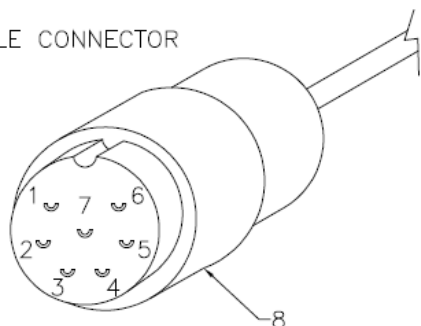

- 1 INPUT +
- 2 INPUT -
- 3 SENS -
- 4 SENS +
- 5 OUTPUT -
- 6 OUTPUT +
- 7 not connected
- 8 SHIELD TO BE FOLDED AND PLACED UNDER THE CONNECTOR CABLE TIGHTENER